

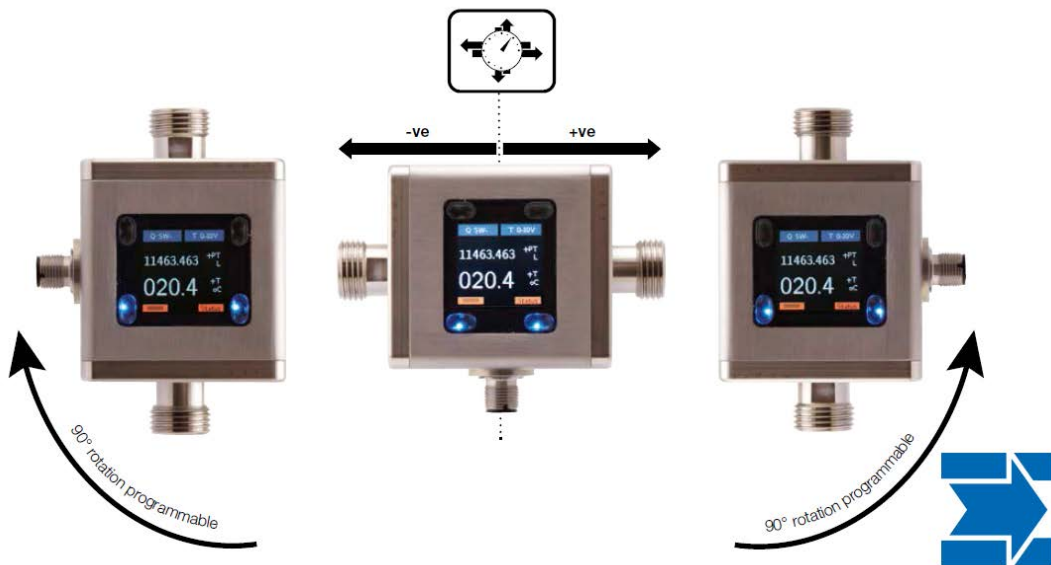

Operating Instructions for Magnetic Inductive Flowmeter Model: MIM



We don't accept warranty and liability claims neither upon this publication nor in case of improper treatment of the described products.

The document may contain technical inaccuracies and typographical errors. The content will be revised on a regular basis. These changes will be implemented in later versions. The described products can be improved and changed at any time without prior notice.

© **Copyright**

All rights reserved.

1. Contents

1. Contents.....	2
2. Note	4
2.1 Overview of the device functionality.....	4
3. Instrument Inspection.....	5
4. Regulation Use	5
5. Environment.....	5
6. Operating principle	6
6.1 General.....	6
6.2 Minimum electrical conductivity / Gas bubbles	6
6.3 Deposits.....	6
6.4 Measuring electrodes	7
7. Mechanical connection.....	7
7.1 Check operating conditions.....	7
7.2 Installation.....	7
8. Electrical Connection	9
8.1 General.....	9
8.2 Pin assignment	10
8.3 Connection example outputs:	14
9. Operation and menu structure	15
9.1 General.....	15
9.2 Measuring mode.....	16
9.3 Menu Mode.....	19
10. Device configuration.....	21
10.1 Sequence of device parameterization.....	21
10.2 Language.....	21
10.3 Display	22
10.4 Measurement.....	24
10.5 Dosing function	32
10.6 Outputs	32
10.7 User service.....	45
10.8 Service / Factory service.....	46
10.9 Info.....	46
10.10 Device default settings.....	46
11. Status.....	47
12. Dosing function	48
13. IO-Link function	52
13.1 Specification	53

14. Technical Information.....	54
15. Order Codes	57
16. Dimensions	59
17. Disposal	61
18. Appendix.....	62
18.1 IO-Link process data structure.....	62
18.2 IO-Link diagnosis information	63
18.3 IO-Link system command table	64
18.4 IO Link ISDU parameter table.....	65
19. Manufacturer's declaration.....	77
20. Confirmation for contact with drinking water	78
21. EU Declaration of Conformance	79
22. UK Declaration of Conformity.....	80

Manufactured and sold by:

Kobold Messring GmbH
Nordring 22-24
D-65719 Hofheim
Tel.: +49(0)6192-2990
Fax: +49(0)6192-23398
E-Mail: info.de@kobold.com
Internet: www.kobold.com

2. Note

Please read these operating instructions before unpacking and putting the unit into operation. Follow the instructions precisely as described herein.

The instruction manuals on our website www.kobold.com are always for currently manufactured version of our products. Due to technical changes, the instruction manuals available online may not always correspond to the product version you have purchased. If you need an instruction manual that corresponds to the purchased product version, you can request it from us free of charge by email (info.de@kobold.com) in PDF format, specifying the relevant invoice number and serial number. If you wish, the operating instructions can also be sent to you by post in paper form against an applicable postage fee.

The devices are only to be used, maintained and serviced by persons familiar with these operating instructions and in accordance with local regulations applying to Health & Safety and prevention of accidents.

When used in machines, the measuring unit should be used only when the machines fulfil the EC-machine guidelines.

as per PED 2014/68/EU

In acc. with Article 4 Paragraph (3), "Sound Engineering Practice", of the PED 2014/68/EU no CE mark.

Diagram 8, Pipe, Group 1 dangerous fluids

2.1 Overview of the device functionality



Depending on the installed device firmware, the MIM device may have different functionalities. The functional extensions are shown in the following table.

Function extension	Available from firmware version
Dosing function	REV180118
Menu languages Simulation function User function keys Analogue output 2-10 V _{DC} Analogue output behavior acc. to NAMUR NE43	REV180514
IO-Link Control input	REV190320
Additional flow units L/s and mL/s	REV191030
Filter function for flow and temperature measurement	REV200608

The installed software version is displayed after starting the device below the manufacturer logo in the form REVxxxxxx for approx. 2 sec.

3. Instrument Inspection

Instruments are inspected before shipping and sent out in perfect condition. Should damage to a device be visible, we recommend a thorough inspection of the delivery packaging. In case of damage, please inform your parcel service / forwarding agent immediately, since they are responsible for damages during transit.

Scope of delivery:

The standard delivery includes:

- Electromagnetic Flowmeter model: MIM

4. Regulation Use

The MIM flowmeter has been specially developed for the measurement, display and transmission of both, flow rates and temperature of conductive liquids. The instrument has a graphic TFT display, rotatable in 90 ° steps and can display flow rate, temperature, daily volume counter (resettable) and total volume counter in the units of measurement selected by the operator. A clear menu guides the user through the parameterization of the device, which largely eliminates the need to look into the operating instructions.

Any use of the magnetic flowmeter, model: MIM, which exceeds the manufacturer's specification, may invalidate its warranty. Therefore, any resulting damage is not the responsibility of the manufacturer. The user assumes all risk for such usage.

5. Environment

The MIM device with stainless steel housing and stainless steel electrodes is weatherproof and conforms to protection class IP67. The meter is designed for harsh indoor or outdoor environments and complies with Directive 2014/30/EU (Electromagnetic Compatibility).

To avoid moisture in the device from condensation, a pressure compensation element is integrated on the front.

This element must not be pierced.

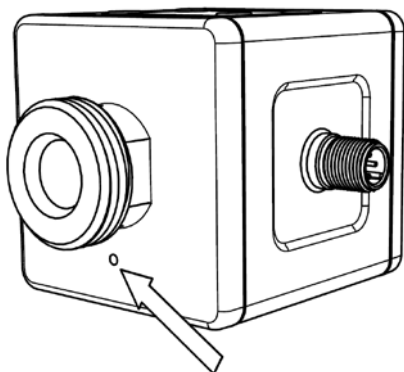

6. Operating principle

6.1 General

The new KOBOLD MIM Flowmeter is designed to measure and monitor small and medium flows of conductive fluids in piping.

The device works on the magnetic-inductive measuring principle. According to Faraday's law of induction, a voltage is induced in a conductor moving in a magnetic field. The electrically conductive measuring medium corresponds to the moving conductor in the process. The voltage induced by the measuring medium is proportional to the flow rate and thus a measure of the volume throughput. Prerequisite is a minimum electrical conductivity of the flowing medium. The induced voltage is fed to a measuring amplifier via two electrodes, which are in conductive contact with the medium. The volume flow is calculated via the defined pipe diameter.

The measurement is independent of the medium and its physical properties such as density, viscosity and temperature. The device can be configured via the display. There are two outputs available, which can each be configured as alarm, frequency, pulse, voltage, and current outputs.

The device also provides a dosing function. The dosing function can be activated in measuring mode via the four buttons. The dosing function controls simple filling tasks and also measures flow rate and partial amount.

6.2 Minimum electrical conductivity / Gas bubbles

For the correct function of the instrument, it is necessary that the flow channel is always completely filled with medium. From a minimum electrical conductivity of 20 $\mu\text{S} / \text{cm}$, the MIM operates within the specified error limits. The conductivity of the medium is constantly monitored by the device electronics. If the electronics detects that the minimum conductivity has fallen below min. value, this is signaled by displaying the error message 'Empty pipe' and the flow rate reading is set to '0'. Air bubbles in the flowing medium or media with varying conductivity in the range of the minimum conductivity can disturb the measuring function and reduce the measuring accuracy of the MIM. Gases contained in the liquid are also measured as a flow volume and lead to measurement errors. If necessary, install appropriate vents in the flow of the unit.

6.3 Deposits

Minor deposits on the measuring tube generally do not affect the measuring accuracy unless their conductivity deviates significantly from the liquid. For liquids that have a tendency to deposit, periodically inspect the meter tube and, if necessary, clean it.

6.4 Measuring electrodes

The MIM uses electrodes with galvanic tapping. They are in direct contact with the medium. The standard electrodes are made of stainless steel 1.4404.

In very rare cases (e.g. oils or fats in the metered medium), electrically insulating deposits on the meter electrodes cannot be ruled out. Such deposits would cause a failure of the meter.

In such cases, the electrodes must be cleaned with a soft brush and a grease solvent.

7. Mechanical connection

7.1 Check operating conditions

- flow rate
- max. operating pressure
- max. operating temperature

In general, MIM is subjected to the same loads as the piping into which it is installed. The MIM should therefore be kept away from extreme loads, such as pressure surges with strong, dynamic pipe movements, vibrations in the proximity of centrifugal pumps, high temperature media, flooding etc.

7.2 Installation

- Remove all packing materials and transport retainers and ensure that no such materials remain in the device.
- It can be installed in vertical, horizontal or rising pipes. Flow in direction of the arrow.
- Avoid pressure and tensile load.
- Mechanically secure the inlet and outlet pipe at a distance of 50 mm from the connections.
- Avoid valves or large reduction on the inlet section (this increases the inaccuracy of measurements).
- Check the leak tightness of the connections.



While mounting MIM hold the flowmeter from spanner surface (not from the housing) with the help of spanner. Take into account the tightening torque.

MIM-

Nominal size	Tightening torque
1/2"	22 to 24 Nm
3/4"	28 to 30 Nm
1"	28 to 30 Nm

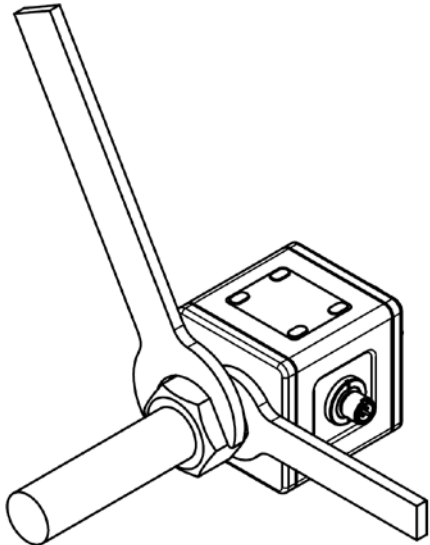

Inlet and outlet run

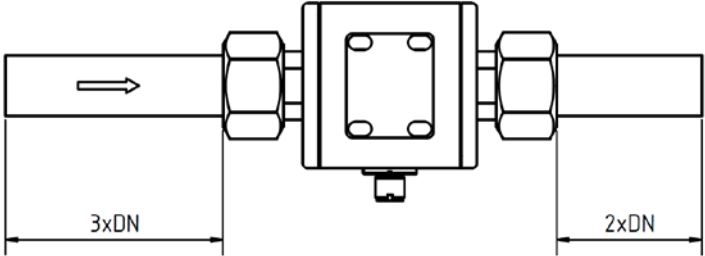

Installation from top to bottom

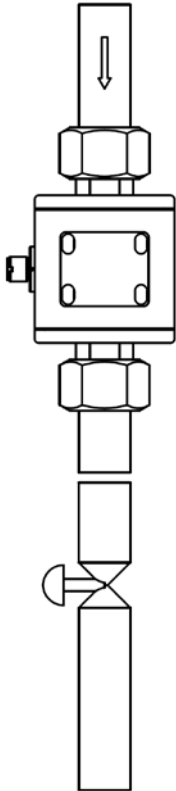

avoid these installation locations

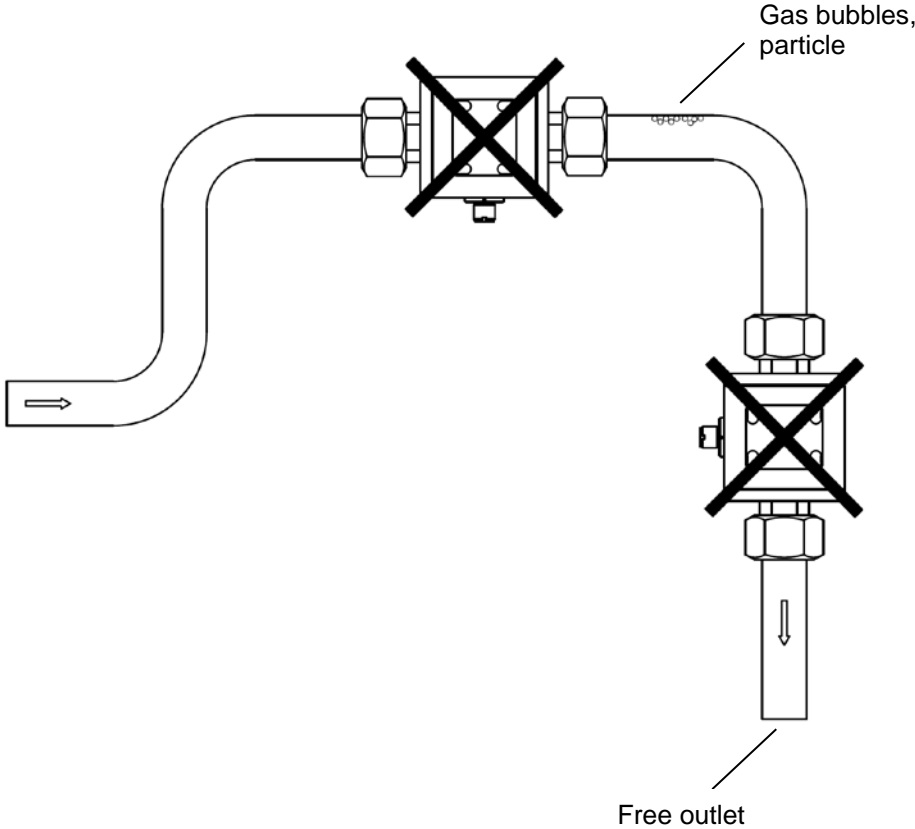

8. Electrical Connection

8.1 General



Attention! Make sure that the voltage values of your system correspond with the voltage values of the measuring unit.

- Make sure that the supply wires are de-energised.
- Connect the supply voltage and the output signal **to the plug PIN's as stated below.**
- We recommend the use of wires with cross sectional area of min. 0.25 mm².



Attention! The measuring electrodes are galvanically connected with the reference potential of the supply voltage and the signal output.

8.1.1 Grounding/ Earthing

If the device is installed in a continuously grounded / earthed metallic pipe, no additional grounding / earthing of the housing is generally necessary. When installing in a plastic pipe or any ungrounded pipe, the housing must be earthed at the side threaded hole (M4) to ensure proper functionality of the MIM. **If a class 2 switched-mode power supply (all-insulated, without an external protective earth connection) is used for the power supply, the grounding must be connected to ensure functionality.** A M4 screw (thread length max. 8 mm), a matching washer, a ring cable lug and a toothed lock washer are required for correct installation.

These mechanical parts are not part of the delivery.

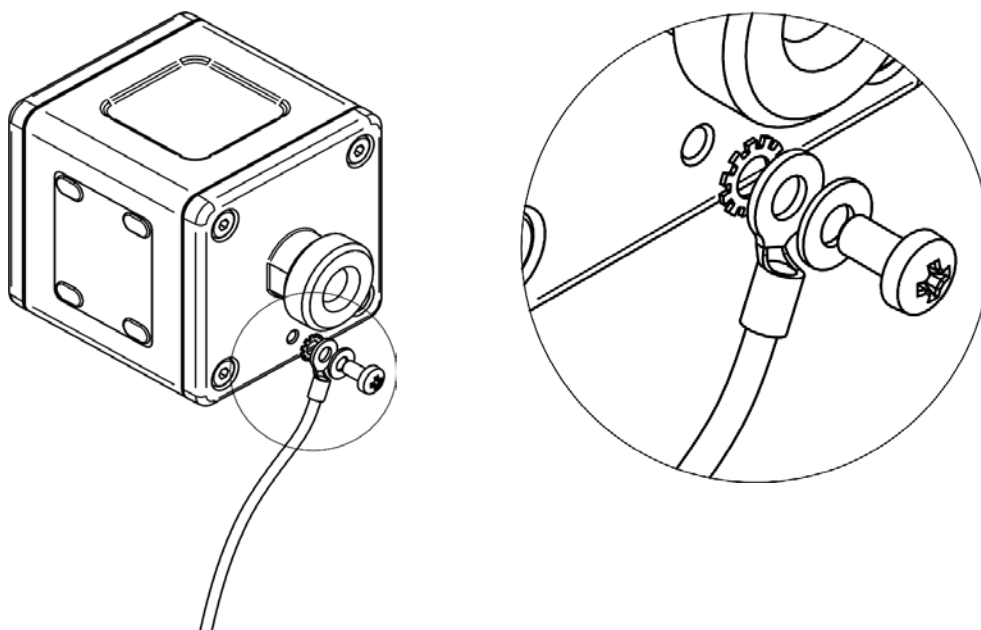

8.2 Pin assignment

8.2.1 External connection with electrical connector M12x1 4-pin for options C3T0 / Exx0 and Pxx0

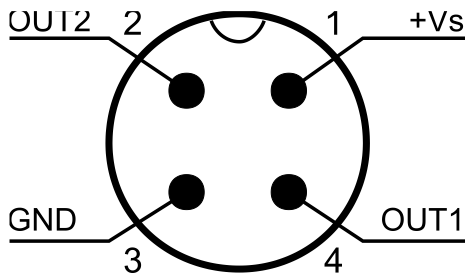

8.2.2 Connection Exx0 / Pxx0 sensor

For the remote versions Pxx0 (PVC cable) and Exx0 (ETFE cable), the sensor and transmitter are delivered ex works with the cable connected.

The on-site installation may require dismantling the cable and reconnecting it later.



Note:

In principle, the cable can be shortened by the user on the transmitter side and connected to the transmitter again after appropriate assembly.



Attention!

A customer extension of the connection cable is not recommended because of the necessary continuous shielding and leads to malfunction of the device. The cable permanently connected to the sensor must not be disassembled.

Wiring diagram Transmitter

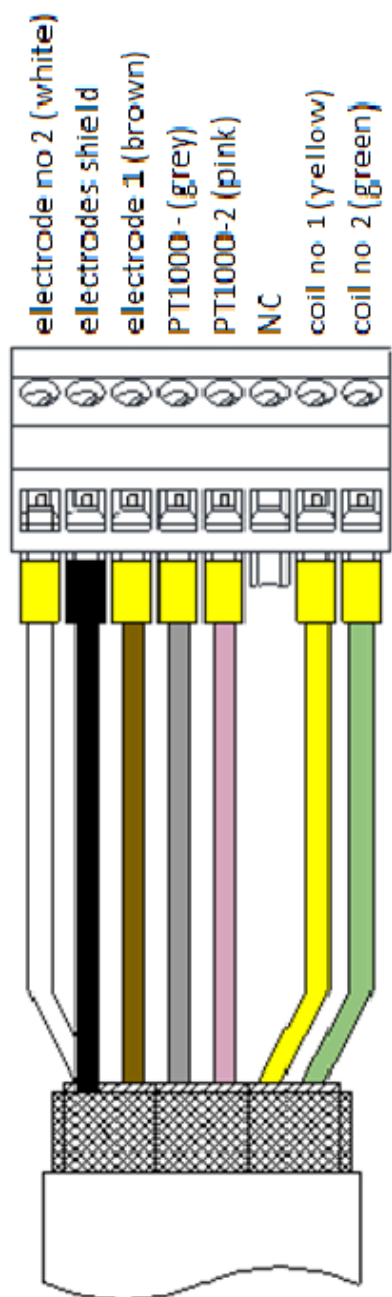

Termination Connection cable
 (PVC and ETFE cable)

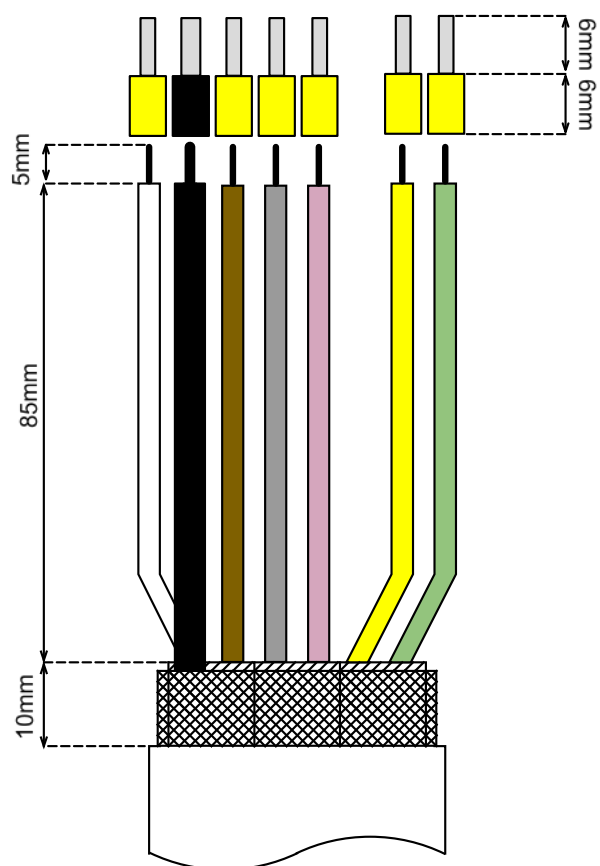

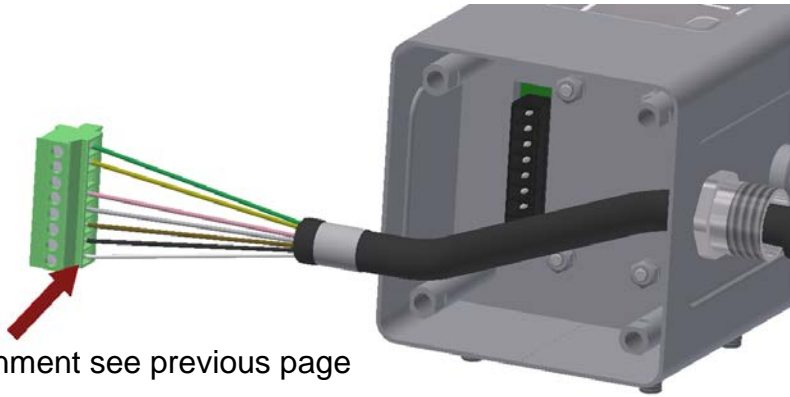

Pin assignment see previous page

Insert pre-assembled cable through the cable gland and connect to the connector strip



Pull back the cable and put the contact spring on the outer shield

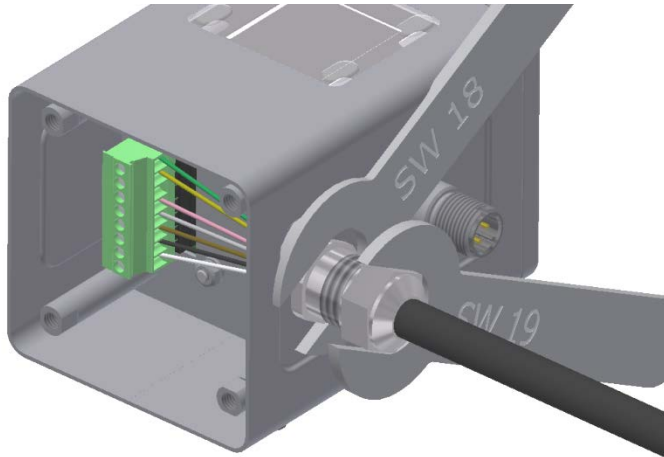

Push the cable into the cable gland, insert the plug connector and tighten the hexagon nut of the cable gland with SK key SW 19 and lock with SW 18

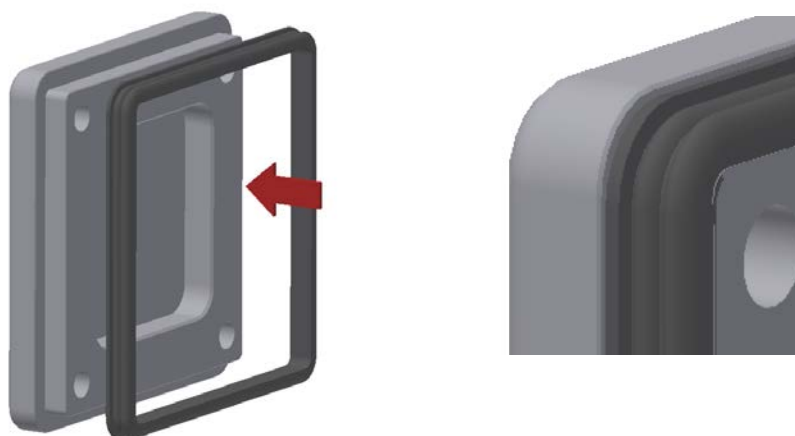

Insert gasket, make sure gasket is seated correctly

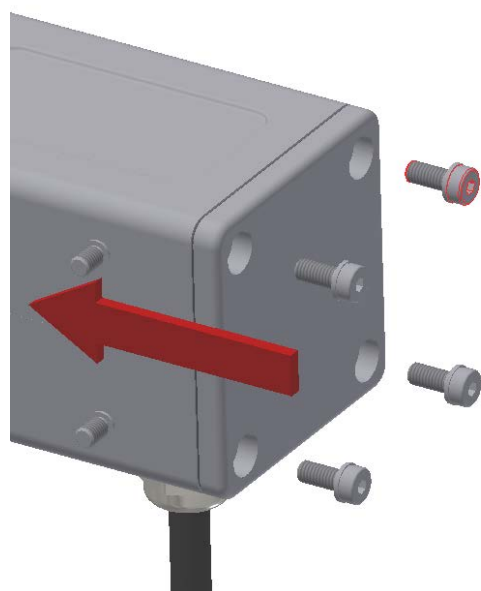

Put the laminated seal disc on the screw and screw the threaded connection in the housing.
When tightening the screws, reduce the gap between sheet metal housing and the cover to ~ 0.5 mm

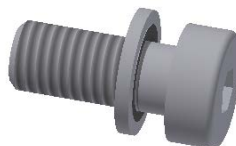

8.3 Connection example outputs:

OUT2: analogue output 4-20 mA
 OUT1: analogue output 0-10 V

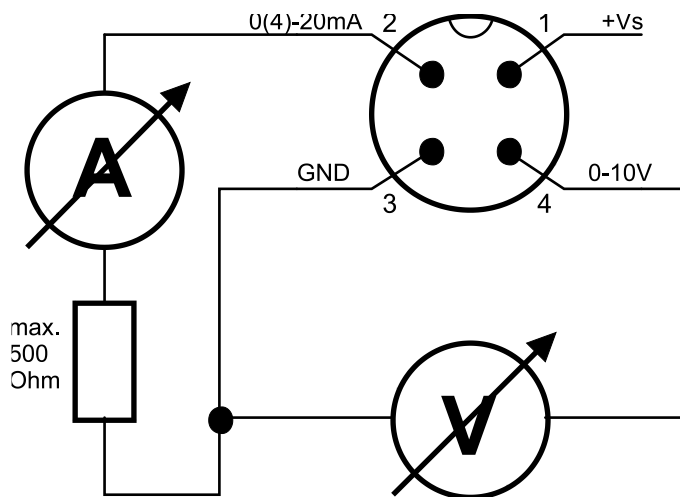

Configurable output functions:

Out 1	Out 2
analogue output 4-20 mA	analogue output 4-20 mA
analogue output 0-20 mA	analogue output 0-20 mA
analogue output 2-10 V	analogue output 2-10 V
analogue output 0-10 V	analogue output 0-10 V
alarm output	alarm output
pulse output	pulse output
frequency output	frequency output
communication mode KofiCom	
communication mode IO Link	
control input	
control input dosing function	dosing output

9. Operation and menu structure

9.1 General

9.1.1 Operation of the optical buttons

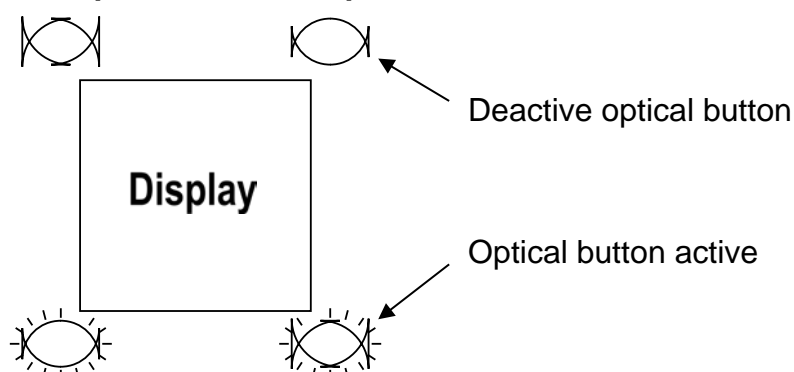

An optical button is located at each corner of the TFT display. The operability of the respective buttons is signaled by blue backlighting; therefore, non-backlit buttons are disabled and cannot be operated. To operate the keys, the finger must be placed on the key-dome and raised again. The orange background of the button symbols is briefly displayed in blue as visual feedback for a detected key press.

To avoid accidental operation in measuring mode, the operator must hold down the menu button for 3-5 seconds to activate the function. If the menu button is held down for more than 3 seconds, the blue backlighting will begin to flash to alert the user to release the button.

The operation of the optical buttons can also be done with gloves or other optically reflective objects. Suitable types of gloves are: cotton and textile gloves, light leather gloves, hygiene gloves made of latex and lightly rubberized work gloves. Black-coated work gloves of all kinds are not suitable. Light dirt on the surface usually does not interfere with the key function.

9.1.2 Function of the control buttons

The function of each control key can be recognized by the respective symbol displayed in the corners of the TFT display.

key symbol	designation	function	
		Measuring mode	menu mode
	menu mode	Activate menu mode hold 3-5 sec.	-
	info display	opens the info menu	-
	down	-	Scroll down menu / decrease numeric value when entering numeric value
	up	-	Menu scroll up / Increase the number

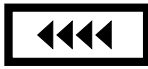
key symbol	designation	function	
		Measuring mode	menu mode
			value for numeric value input
	forward	-	Menu level lower / forward (last menu level: Save value)
	backward	-	Menu function: menu level higher / back (last step: exit menu)

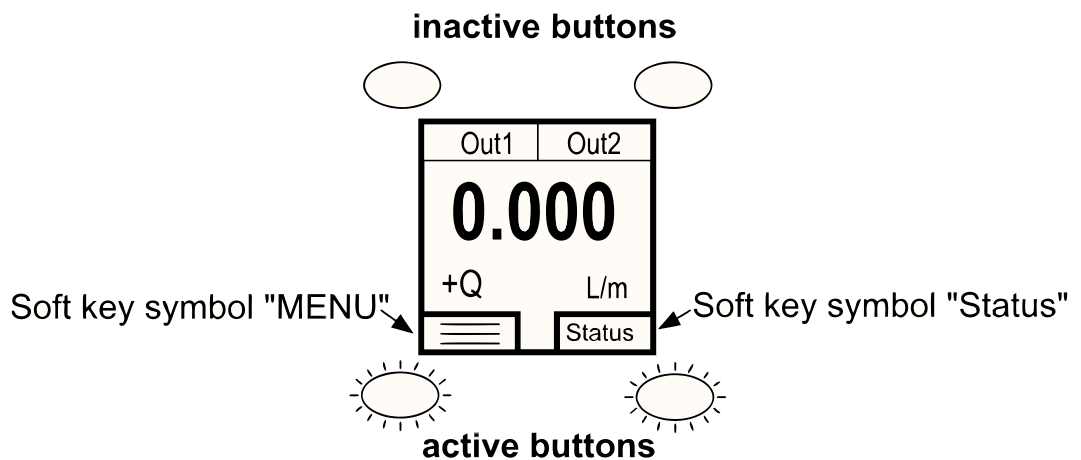

9.2 Measuring mode

After applying the supply voltage, the device starts in measuring mode. In this mode, the measured values of the respective measuring variables are continuously recorded; the current instantaneous flow values, temperature values and the volume counter readings are cyclically calculated and displayed according to the type of display.

In addition to the main display, the states and configuration of the outputs are shown in the display. If the corresponding output is configured as an alarm output, the status is also displayed with a green or red background color. If the background color is green, the set threshold value is exceeded; if it is red, the current value is still under threshold.

Measurement Mode Display Layout 'Single'

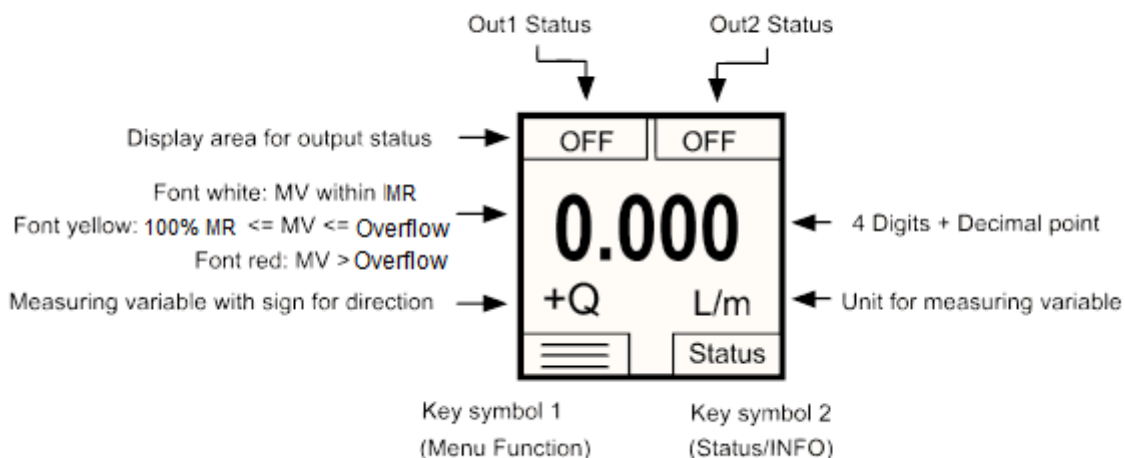

The measurement variables are represented by their corresponding symbols:

Menu entry	Mesuring variables Symbol	Description
Flow	Q	Flow rate
Volume	AC	Accumulated totalizer
Temperature	T	Medium temperature
Part volume	PT	Partial totalizer

The outputs and their status are shown on the display as follows:

Output function OUT1/2	Symbol	Representation
disable	OFF	
Analog output 4-20mA	4-20mA	
Analog output 0-20mA	0-20mA	
Analog output 0-10V	0-10V	
Analog output 2-10V	2-10V	
Alarm output PushPull	SW+-	Background grey/green
Alarm output PNP	SW+	Background grey/green
Alarm output NPN	SW-	Background grey/green
Pulse output	PLS	
Frequency output	FRQ	
Communication mode KofiCom (only OUT1)	KofiCom	Use only for factory service
Communication mode IO-Link (only OUT1)	IO-Link	
Control input	X CTL	"X" symbol of the selected measuring variable

The measured variables flow, temperature and volume counter can in principle be assigned to each output function. The assignment of the respective output is indicated by the display of the symbol of the measuring variable. The representation of the assignment is independent of the set display layout (single, dual).

Measurement Mode Display Layout 'Dual'

Out 1 configured as switching output pushpull and assigned to flow

Out 2 configured as analogue output 4-20 mA and assigned to temperature

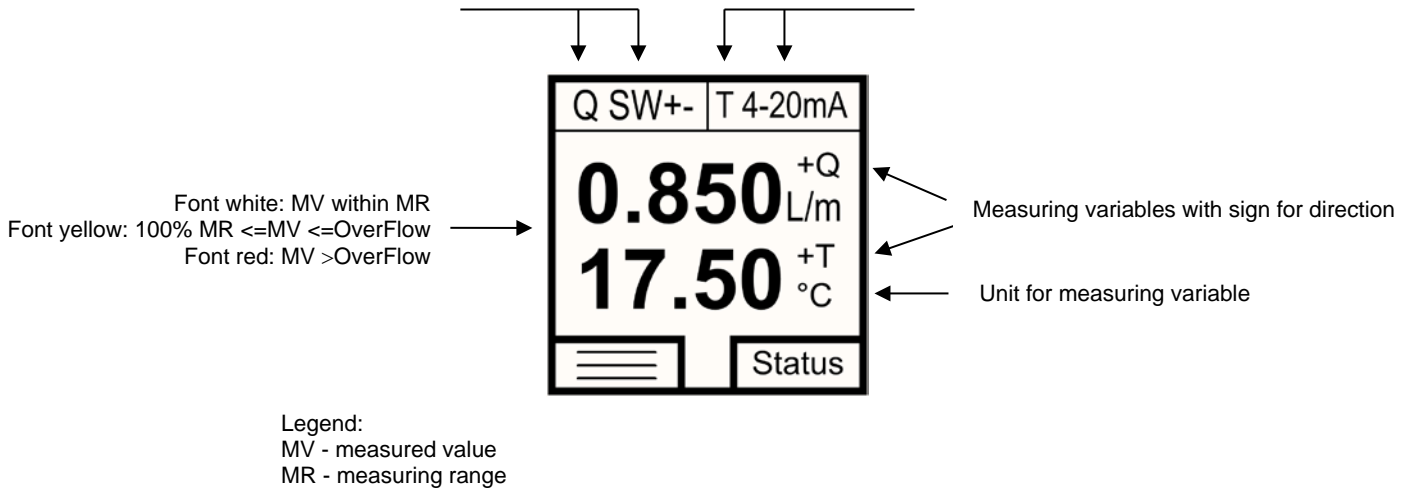

Out 1 configured as pulse output and assigned to partial totalizer

Out 2 configured as analogue output 4-20 mA and assigned to temperature

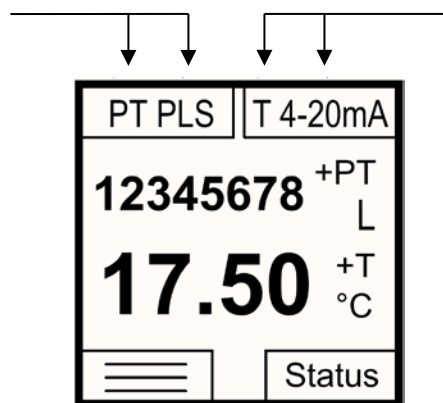

9.2.1 Display area of the flow meters

The number of digits displayed on the volume counter display (partial and total volumetric counters) is limited to max. 8 digits. The partial and total volumetric meters therefore have a smaller font size than the flow and temperature display. If the 8-digit display range of the meter is exceeded, this is indicated by the display of 8 minus characters (-----). In this case, the meter reading can no longer be read. The user now has the option of bringing the counter reading back into the display area by changing the volume counter unit.



9.3 Menu Mode

In menu mode, all device parameters can be set. The individual parameters are arranged in menu groups by function. While the menu mode is activated, the signal processing and the outputs are still active in the background. However, all display parameters and outputs are updated after exiting the menu mode or in the measuring mode.







Note: The menu mode will exit automatically after a certain time without using the buttons, if the parameter "Menu Timeout" is set not equal to "0".

9.3.1 Parameter setting

9.3.1.1 List Selection



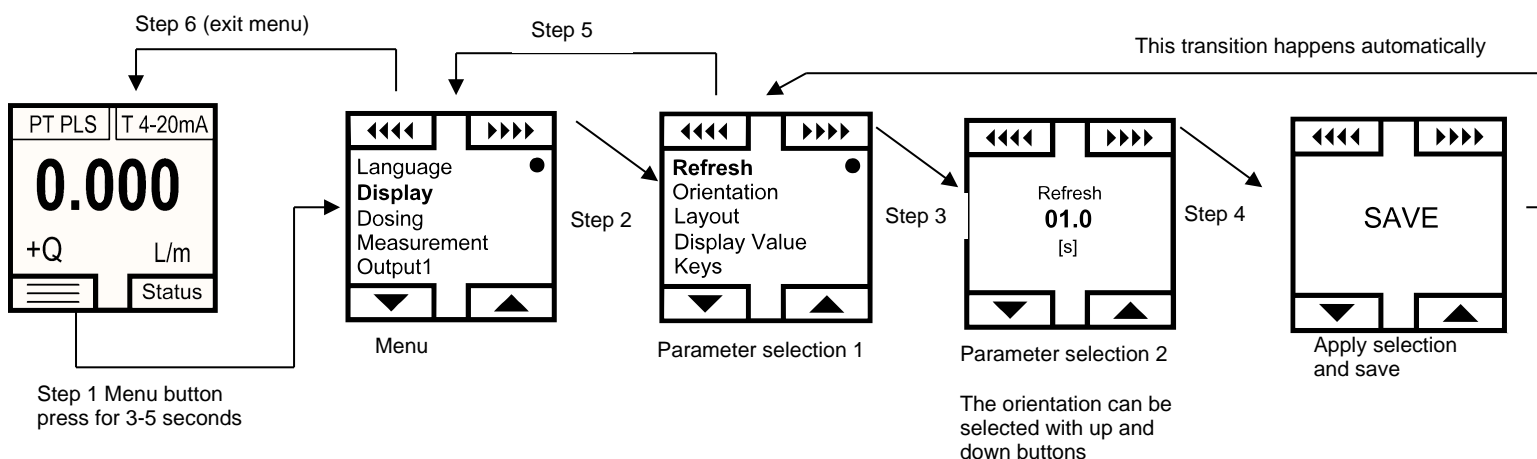

Parameters with predefined selection values are defined by means of list selection. The currently selected menu item is displayed in orange text. The selection can be moved with the   keys, the key  is used to accept the selection.

To activate the menu mode, press the button  for 3-5 seconds. The parameters are divided into main groups and subgroups.

The buttons   are used to select the main groups. In the main menu not all menu groups can be shown on the display at the same time, the list of individual menu items then scrolls up or down when the selection has reached the top or bottom. To choose the selection, the key  is pressed and the device jumps to the corresponding submenu or parameter setting level. For selecting of predefined parameter values  and  are used. After changing the value of the parameter and confirming with  the parameter is saved, and returns to the higher menu level. To return to the main menu or to exit the menu mode, press  (repeatedly).



9.3.1.2 Numerical value input

When setting parameters with a numerical value, the assigned unit is always displayed below the input field in square brackets in the input function. The maximum size and the number of decimal places is fixed and cannot be changed. After calling the input function, first the left, outer digit is displayed in orange. This position can now be adjusted either with the keys   in the value from 0 to 9. By pressing the key , the entry point moves to the right and the next digit can be changed. By pressing the key , the editing point can be moved to the left again. If the editing point is on the far right, the set value is saved by pressing the key  again and switched to the higher-level menu function.

10. Device configuration

10.1 Sequence of device parameterization

The flowmeter MIM is pre-configured in factory. Changing the parameters "Measuring range" and "Sensor constant" or "K factor" is therefore not permitted. The adjustment of these parameters is only possible on the part of Kobold-factory. In the event of subsequent changes to volume or throughput units, the dependent parameters are converted and adjusted accordingly. However, the limit parameters of the switching outputs must always be checked and adjusted manually when adjusting volume or throughput units - these are not automatically converted.

An accidental change of the parameterization can be revised by the function "Reset factory setting" in the menu Userservice / Reset.

10.2 Language

In this menu item the menu language can be changed in English, German, French or Spanish (standard: English).

Parameter table **language**

Sublevel	parameter level	Sub-parameter level 1	Sub-parameter level 2	Sub-parameter level 3	Description	Value range / value list	Standard value LPM version	Standard value GPM version
English					Selects English as the menu language		<i>English</i>	
Deutsch					Selects German as the menu language			
Francais					Selects French as the menu language			
Espanol					Selects Spanish as the menu language			

10.3 Display

10.3.1 Refresh

Parameter "Refresh" defines the time interval within which the measuring variables are displayed. The "Refreshrate" can be increased in steps of 0.5 sec. to 10 sec. An increase in the refresh rate time causes an increased "filtering" of the display value.

10.3.2 Orientation

With the menu item "Orientation" the display can be rotated either clockwise or counterclockwise in 90 ° increments. As the display rotates, both the display contents and the function of the 4 control buttons are turned.

10.3.3 Layout

This parameter can be used to configure the display to either show one measurement variable or two measurement variables.

10.3.4 Display value

With the aid of this parameter, the measurement variables provided by the transmitter can be displayed. Depending on the 'Layout' display, either one or two measuring variables can be displayed.

10.3.5 Keys HOTKEYs

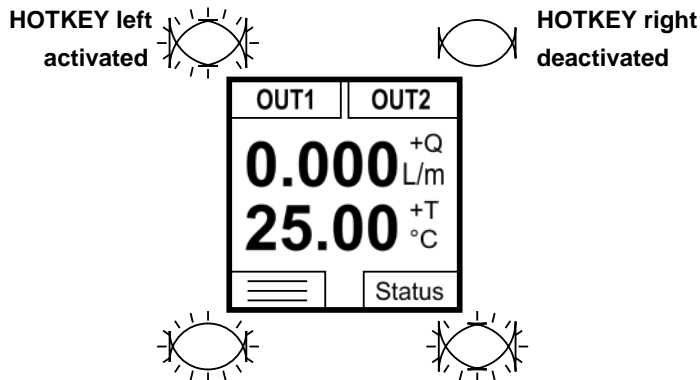

Two independent user keys are available, which can be individually assigned with different display functions. The 2 user keys are available in measurement mode top right and left. If the buttons are activated, they are backlit in blue and the programmed function can be executed by touching.

The following functions are available:

reading	MIN/MAX / Reset	Value display / Reset
flow	Yes / Yes	Yes / No
Temperature	Yes / Yes	Yes / No
Partial quantity counter	Not available	Yes / Yes
Totalizer	Not available	Yes / No

The called hotkey function remains permanently activated and can only be left by pressing the key . A direct reset function is available for the MIN / MAX measured value function and the partial quantity counter.

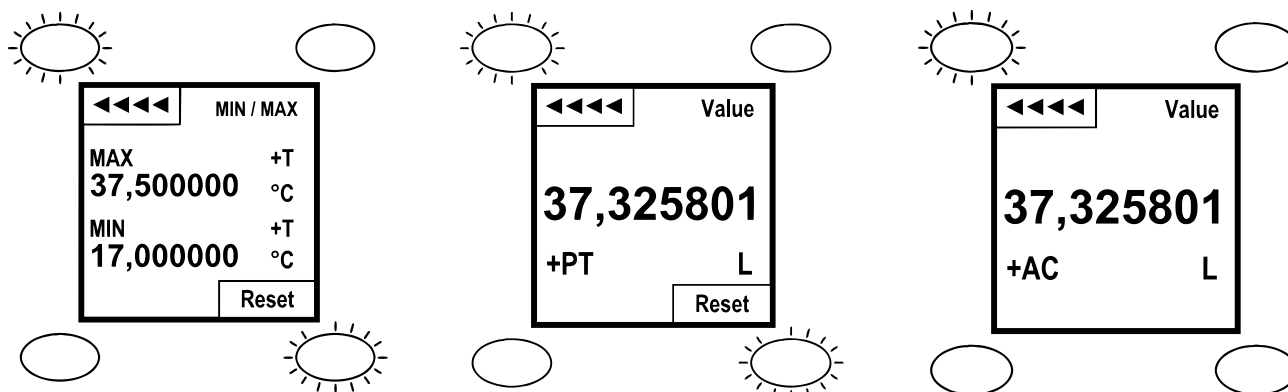

10.3.6 Menu Timeout

The menu timeout time defines the time after which the menu function is automatically exited without pressing a key. In the setting "0 s" this function is deactivated and the menu function can only be left by hand by pressing the back key several times.

Parameter table Display

Sublevel	Parameter level	Sub-parameter level 1	Sub-parameter level 2	Sub-parameter level 3	Description	Value range/ value list	Default value LPM version	Default value GPM version			
Refresh	<i>value input</i>				Sets the display refresh rate	0.5-10 sec	0.5 sec				
Orientation	<i>rotate CW</i>				Rotates the display 90 ° clockwise		Landscape				
	<i>rotate CCW</i>				Rotates the display 90 ° counterclockwise						
Layout	Single				Shows a measured value in the display area				Double		
	Double				Shows two measured value in the display area						
display value	Upper display	<i>list selection</i>			Sets the reading for the upper display	<i>Flow, volume, temperature, part volume</i>	Flow				
	Lower display				Sets the reading for the lower display		Temperature				
Keys	Hotkeys	left	Flow	<i>List selection</i>	Sets the reading and function for the left hotkey	<i>Off, Value, Min / Max</i>	Off				
			Volume								
			Temperature								
			Part volume								
	right	Flow	<i>List selection</i>	Sets the reading and function for the right hotkey	<i>Off, Value, Min / Max</i>	Off					
		Volume									
		Temperature									
	Part volume										
	sensitivity	<i>list selection</i>			Sets the sensitivity for the optical buttons	Low	Low				
Menu Timeout	<i>value input</i>				Defines the time after which the setting menu is automatically exited without pressing a key (0 = deactivated)	0.5 to 60 s	15 s				

10.4 Measurement

The Measurement menu lists the measurement variables that the transmitter provides. For magnetic inductive flowmeter, these are:

- Flow
- Volume (total volume counter)
- Temperature
- Part volume

Each measurement variable is still divided into its own submenu. In the submenu, all parameters relating to the respective measuring variables can be adjusted.

10.4.1 Flow

10.4.1.1 Unit

The displayed unit for the flow measurement can be selected from various predefined standard units. It is also possible to define a user-defined unit ("user"), here the "user unit" must be in LPM (liters / min.) be programmed:

e.g. Unit User = 100 LPM, if Q = 500 LPM then the display shows 5 users.

10.4.1.2 Filter function

The measured value filter filters the display value and most electrical output signals (analog outputs / frequency outputs / switching outputs).

A separately adjustable filter is available for each measured value (flow and temperature). In the factory setting, the standard filter with low filtering and active step detector is activated. Volume counters and pulse outputs are generally not filtered.

There are 3 different filter types available, so that a suitable filter functionality is available for as many applications as possible. The time base of the filter function is approx. 20 ms.

Filter type	Filter factor [n]	Step detector	Description
Standard	1 - 250	Yes	Rolling filter type, the size of the filter factor determines the number of temporarily stored and used averaging values. $MV_{AVG} = \frac{MV_0 + MV_{-1} + \dots + MV_{-n}}{n}$
IIR		No	With this filter type, depending on the filter factor, part of the last measured value average is added to the current average value. The filter corresponds to a digital low-pass filter of the 1st order with an infinite step response. The filter effect achieved is not linear to the parameter filter factor. A high filter effect is only achieved with filter values > 200. $MV_{AVG} = b * MV_0 + (1 - b) * MV_{AVG-1}$ with $b = \frac{251 - filter\ factor}{250}$
Exp. smoothing		No	The filter type works on the principle of exponential smoothing. The step response has an exponential course. The filter factor is proportional to the response time t_{90} of the step response. This enables the greatest filter effect to be achieved. $t_{90} \sim filter\ factor * 75ms$ $MV_{AVG} = \frac{MV_{AVG-1} * (n - 1) + MV_0}{n}$
with: MV_{AVG} = filtered measured value, MV_{AVG-1} = last filtered measured value, MV_0 = current measured value MV_{0-1} = last measured value			

Application areas of the filter types

Standard	<p>Standard filter with step detector with fast response time with real changes in measured values. This filter type has a max. time lag of filter factor * 20 ms</p> <p>This filter smoothes slight to medium fluctuations in measurement values without the disadvantage of increasing the response time in flow monitoring applications.</p>
IIR	<p>Simple digital filter with lag, no step detector</p> <p>This filter can be used for slight to medium pulsating fluctuations in measured values. With strong filtering, there is a correspondingly long lag of the filtered measured value in case of real measured value changes. Not suitable for flow monitoring applications with a large filter factor.</p>
Exp. Smoothing	<p>Simple smoothing filter with lag, no step detector</p> <p>This filter can be used for strong pulsating fluctuations in measured values. With strong filtering, there is a long lag of the filtered measured value with real measured value changes.</p> <p>The lag can be determined via the filter factor to: $t_{90} \sim \text{filter factor} * 75\text{ms}$</p> <p>Not suitable for flow monitoring applications with a large filter factor.</p>

Step detector (only available with standard filter)

The step detector integrated in the standard filter can detect the tendency of a real change in the measured value and temporarily bridge the filter function after detection of a step in the measured value in order to minimize the step response time. A step (sudden change) in the measured value can be detected both with increasing and with falling measured value. The step detector is set by the step threshold (*JD threshold*) and an interference suppression factor (*JD-ConfFactor*). The behavior at the beginning of the measuring range can be made "interference suppressed" with the parameter *0-ConfFactor*.

JD Threshold	The value of the step threshold is normalized according to the span of the measuring range, the default value 0.1 means 10% of the full scale value.
JD ConfFactor	Defines the factor by which the step threshold must be exceeded in succession without interruption before the step detector actually becomes active. If the end value of the interference suppression counter is not reached, it will be reset. However, if the final value of the counter is reached, the step detector is active and all filter buffers are overwritten with the current measured value.

0-ConfFactor

If the measured values are at the start of the measuring range, below which the measured values are set to 0, the zero measured value suppression function may become active. The parameter *0-ConfFactor* defines a counter value, how often the measurement range start value must fall short of in succession and without interruption before the measurement value is actually set to "0". This function serves to stabilize the measured value in the area of the start of the measuring range. Like the step detector, this function works in both directions, i. e. from measuring range => 0 and from 0 => measuring range.

Notes for applications with pulsating flows:

If flow pumps generate pulsating flow (e.g. peristaltic pumps or diaphragm pumps), the following instructions must be observed:

- The pulsation flow peaks must always be within the measuring range of the device
- If possible, install a pulsation damper
- The pulsation frequency of the pump should not be close to the 50 Hz frequency or its divider (25 Hz, 12.5 Hz, 6.25 Hz etc.), otherwise cyclical measurement fluctuations may occur.
- The measured value display (and the electrical analog and frequency outputs) can be most effectively dampened using the filter function "exp. Smoothing"

10.4.1.3 Separation

The parameter Separation sets the flow rate below which the measured value is set to "0". If this function is active, the flow value "0" is shown in blue colour in the display. If the parameter value is set smaller than the start of the measuring range (see technical data), the display value and all signal outputs assigned to it remain at "0" as long as the measured value does not exceed the start of the measuring range.

10.4.1.4 Simulation mode

See section 10.4.5

10.4.2 Volume**10.4.2.1 Counter type**

Absolute:

Regardless of the flow direction, the calculated partial volume is added to the counters.

Bidirectional:

Depending on the flow direction, the calculated partial volume is added or subtracted to the counters. If the measured flow value is negative, the volume value goes down from measurement to measurement (possibly into the negative range).

Volume measurement by different totalizer types

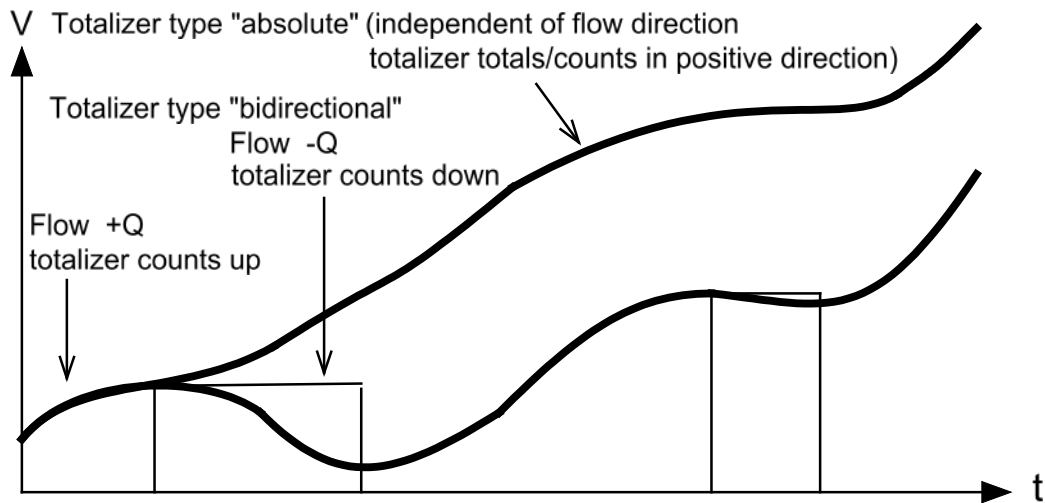

10.4.2.2 Unit of the total volume counter

The parameter "Unit" determines the volume unit of the total volume counter. The listed volume units are available. When changing the volume unit, the current counter reading is converted to the new volume unit.

It is also possible to define a user-specific unit "User". Here the "user unit" must be programmed in liters: e.g. unit "User" = 100 L, if the internal volume value reaches 500 L, then 5 "User" is shown on the display.

10.4.3 Temperature

10.4.3.1 Temperature Unit

The displayed unit for the temperature measurement can be selected from various default units. It is also possible to define a user-defined unit ("user"), in which case the "user unit" must be programmed in °C.

e. g. Unit "user" = 50 °C, if T = 50 °C then the display shows 1 user.

10.4.3.2 Simulation function

See section 10.4.5

10.4.4 Part Volume

10.4.4.1 Counter type

Absolute:

Regardless of the flow direction, the calculated partial volume is added to the counters.

Bidirectional:

Depending on the flow direction, the calculated partial volume is added or subtracted to the counters. If the measured flow value is negative, the volume value goes down from measurement to measurement (possibly into the negative range).

10.4.4.2 Unit of the part volume counter

The parameter "unit" defines the volume unit of all volume meters. The listed volume units are available. When changing the volume unit, the current counter readings are converted to the new volume unit.

It is also possible to define a user-specific unit "User". Here the "user unit" must be programmed in liters: e.g. unit "User" = 100 L, if the internal volume value reaches 500 L, then 5 "User" is shown on the display.

10.4.4.3 Memory reset

In this menu, the part quantity counter can be reset.

10.4.4.4 Simulation function

See section 10.4.5

10.4.5 Simulation function

With the simulation function, all available measured values can be simulated independently of each other for a limited time. The simulated measured values have full effect on the displays and outputs.

Each simulation started is automatically stopped after the time set in the "Sim Auto Stop Time" (user service) parameter (1 to 30 min) or after the programmed intervals have expired.

The following measured values can be simulated:

Volume flow, temperature and part quantity counter

The simulation starts as soon as the simulation is activated and the setting menu is exited. The simulation is interrupted or stopped, if the setting menu is called up. There are 3 different simulation types available for each purpose:

a.) „Triangle“ mode

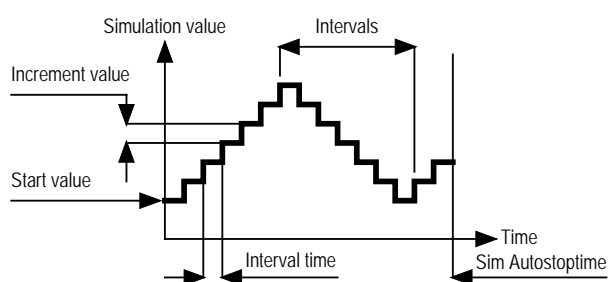

In "Triangle" mode, the simulation value increases continuously in the increment of the parameter "Increment value" and in the interval "Interval time" with the "Start value". After the amount of the parameter "intervals", the simulation value decreases again in the same way, in order to increase again. This

process is repeated continuously until the set time "Sim Auto Stop Time" has expired and the simulation ends.

b.) "Monotonic" mode

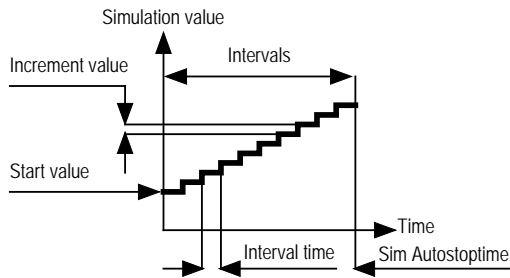

In "Monotonic" mode, the simulation value increases continuously in the step size of the parameter "Increment value" and in the interval "Interval time" with the "Start value". After the amount of "Intervals" or the expiration of "Sim Auto Stop Time", the simulation ends.

c.) "Static" mode

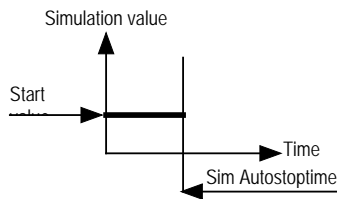

In the "Static" mode, a constant value is output for the measured values flow and temperature. The simulation ends after the set simulation time.

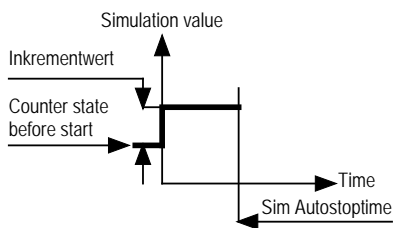

In the "static" simulation for the part quantity counter, the counter is only changed once by the set "increment value" after the start.

When simulating the subset counter, note that in triangle mode, the submenu counter must be in bidirectional mode to achieve the expected effect.

Parameter table **Measuring**

Sublevel	Parameter level	Subparameter level 1	Subparameter level 2	Subparameter level 3	Description	Value range/ value list	Default value LPM version	Default value GPM version
Flow	Unit	List selection			Sets the flow unit	L/m, L/h, m ³ /h, galUS/m, galUS/h, galUK/m, galUK/h, L/s, mL/s, User	L/m	gals/m
	Filter	Type	List selection		See description	Default / IIR / exp. smoothing	standard	
		Filter factor	Value input			1-250	25	
		JD threshold				0.05 – 1.00 [xFs]	0.1	
		JD-ConfFactor				1-25	1	
		0-ConfFactor				1-25	1	
	separation	value input			Sets the value for the low flow cutoff	0 ≤ Value ≤ Range start	Range start	
Simulation mode	See table <i>Simulation mode</i>							
Volume	Counter Type	absolute/ bidirectional			Sets the counting mode		absolute	
	Unit	List selection			Sets the volume unit	ml, L, m ³ , galUS, galUK, User	L	L
Temperature	Unit	List selection			Sets the temperature unit	°C, °F, User	°C	°C
	Filter	Type	List selection		See description	Default / IIR / exp. smoothing	standard	
		Filter factor	Value input			1-250	1	
		JD threshold				0.05 – 1.00 [xFs]	0.1	
		JD-ConfFactor				1-25	1	
		0-ConfFactor				1-25	1	
	Simulations-modus	See table <i>Simulation mode</i>						
Part volume	Counter Type	absolute/ bidirectional			Sets the counting mode		absolute	
	Unit	List selection			Sets the volume unit	ml, L, m ³ , galUS, galUK, User	L	galUs
	memory reset	Yes/No			Sets the counter value to "0"			
	Simulation mode	See table <i>Simulation mode</i>						

10.5 Dosing function

see section 12

10.6 Outputs

The MIM flowmeter provides a total of 2 outputs that are freely configurable. The configuration of the outputs (output 1 and output 2) is done via a wizard function. The wizard function guides the user step by step through all necessary settings.

Steps:

- Select output
- Selection of the source or the measurement variable to be output (Flow, Volume, Temperature, Part volume)
- Selection of an output type (4-20 mA, 0-20 mA, 0-10 V, 2-10 V, alarm, pulse, frequency output, IO-Link, control input)
- Setting the output (scaling, thresholds)
- Save the configuration

The different output types are optimized for different types of applications. The following table contains the application recommendations for the different output types. If the outputs are not used according to the recommendations, measurement deviations can occur and the desired functionality is not achieved.

Application	Output type			
	Analog output (all variants)	Frequency output	Pulse output	Alarm output
Telemetry device	✓	✓		
Limit monitoring				✓
Window monitoring				✓
External dosage			✓	
External volumetric count			✓	

Application table output types

10.6.1 Alarm output

The alarm outputs can be parameterized with a limit value function or a window function.

10.6.1.1 Function

The parameter "*Function*" defines the basic function. Limit value function and window function are available.

Limit value function: The switching output is **active** if the current flow rate value is above the switching threshold. It remains **active** until the measured value has fallen below the switching threshold minus the hysteresis.

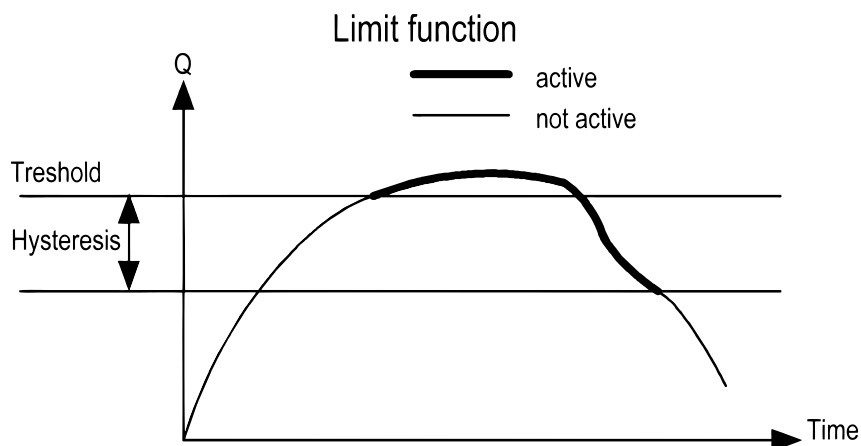

Window function: The switching output is **active** if the current flow measured value is outside a window, which is formed by the "*switching threshold*" and the "*lower threshold*". The monitored window decreases in each case by the amount of the "*hysteresis*". If the switching output is to be **active** within the window, the parameter "*switching function*" must be changed from N/O to N/C.

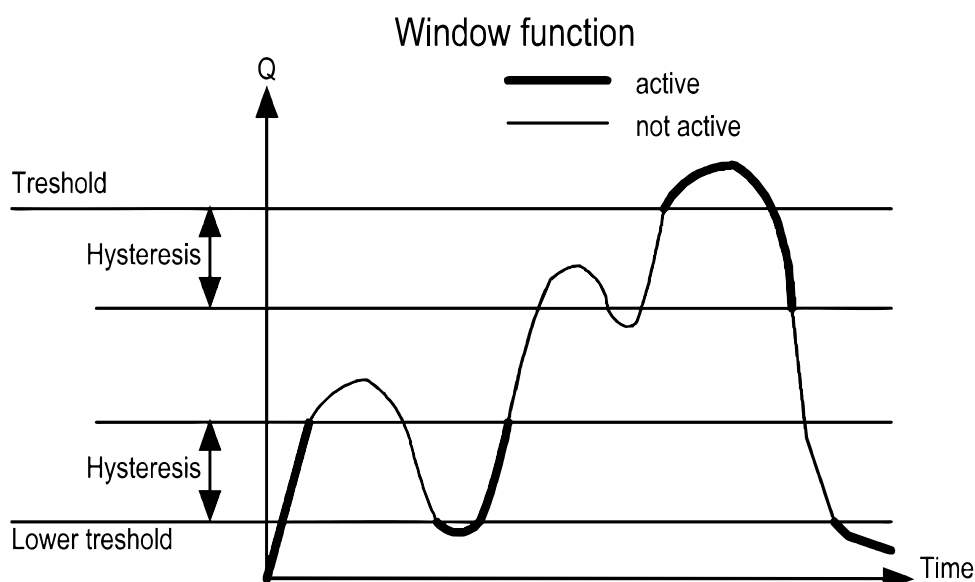

10.6.1.2 Output type

The parameter "*Output type*" defines the function of the transistor output. NPN, PNP or PP (push-pull) output types are available. The push-pull type combines NPN and PNP and is therefore the best choice for most circuits. All outputs are short circuit and overload protected.

10.6.1.3 Switching function

The "*switching function*" defines the mode of operation of the outputs. In the default setting "normally open", the output becomes active (switched) when the measured value exceeds the switching threshold. This feature is also referred to as N.O. In the "*Normally closed*" setting, the output below the switching threshold is already active and is deactivated when the measured value exceeds the switching threshold. This function is also referred to as N.C.

10.6.1.4 Threshold

Threshold for limit value function and upper window point for window function.

10.6.1.5 Lower threshold

The "lower threshold" defines the lower limit when using the window function. When using the limit value function, this parameter remains ineffective. The switching thresholds can be set both positive and negative.

10.6.1.6 Hysteresis

The appropriate setting of the "hysteresis" parameter ensures that the switching outputs do not switch on and off continuously when the current measured value fluctuates around the switching threshold. The hysteresis value should therefore always be greater than the real measured value fluctuations. As a result, a targeted suppression can be achieved.

10.6.1.7 Filter factor (delay)

Further suppression of the switching outputs of fluctuating measuring signals can be achieved by setting the parameter "Filter factor". If this parameter is selected greater than 0, the switching of the output will be delayed accordingly. The "Supp direction" parameter determines whether the deceleration is to be effective when the switching threshold is exceeded or not reached (alternatively in both directions). "High" means that the delay is active when the measured value exceeds the switching threshold, "Down" means corresponding effect when the switching threshold is undershot.

The measured value must stay continuously below or above the switching threshold with the count of [SUPPRESSIONFACTOR] before the switching output will be activated. With this function sporadic limit value overruns can be safely suppressed.

According to the value of the parameter "filter factor", the response time of the output generally increases.

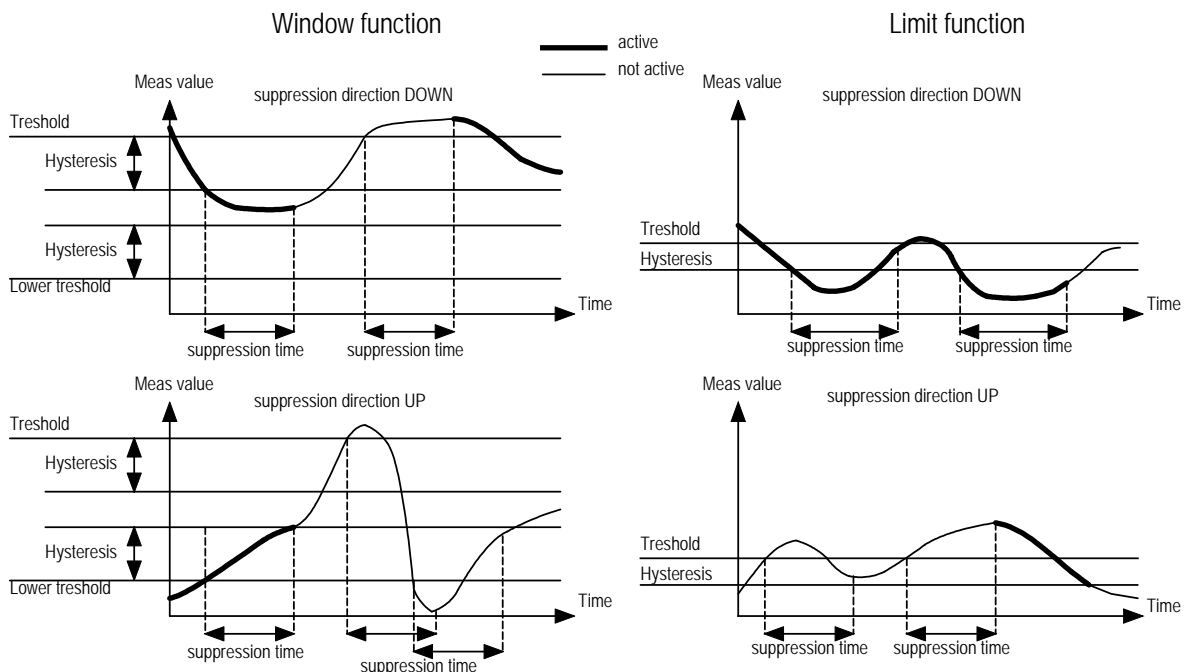

Examples of the effect of the switching delay for window and limit function

10.6.2 Analogue outputs

10.6.2.1 Current output 0(4)-20 mA

The current output gives a measured variable (flow or temperature) in scaled form as a 0 (4) -20 mA current signal.

The current output is scaled via the "Value 20 mA "and" Value 4 mA "(with current output 0-20 mA "Value 0 mA"). By default, the "Value 20 mA" parameter is set to the value for the end of the measuring range, but can be parameterized as desired within the measuring range, but always bigger than the measuring range start value. The parameters "Value 4 mA" / "Value 0 mA" define the measured values for the starting current value, which may also be set freely in the measuring range. Note 1: If the value is set smaller than the end of the measuring range, the accuracy of the output voltage value is reduced.

Note 2: The burden on the current output must not exceed 500 Ω .

10.6.2.2 Voltage output 0-10 V / 2-10 V

The voltage output outputs a measurement variable (flow or temperature) in scaled form as a 0-10 V / 2-10 V voltage signal.

The scaling of the voltage output is done via the parameter "Value 10 V" and "Value 0 V". By default, the "Value 10 V" parameter is set to the value for the end of the measuring range, but can be parameterized as desired within the measuring range, but must always be bigger than the measuring range start value. The parameters "Value 0 V" and "Value 2 V" define the measured values for the start voltage value, which may also be freely set in the measuring range.

The parameters "Value 0 V" and "Value 2 V" define the measured values for the start voltage value, which may also be freely set in the measuring range.

Note 1: If the value is set smaller than the end of the measuring range, the resolution and accuracy of the output voltage value are reduced.

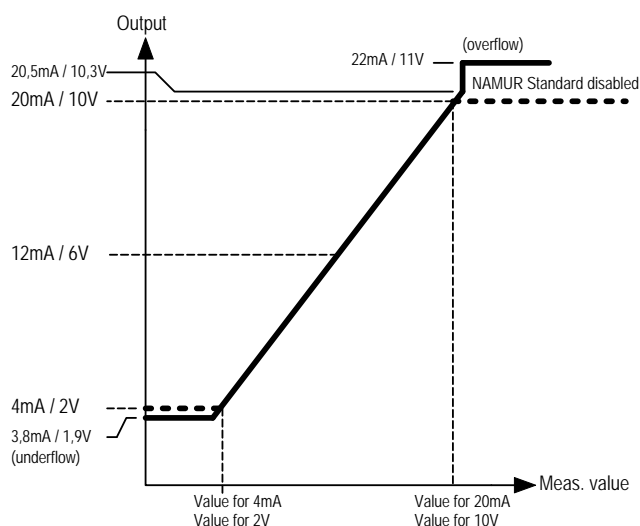

Output behavior 4-20 mA and 2-10 V

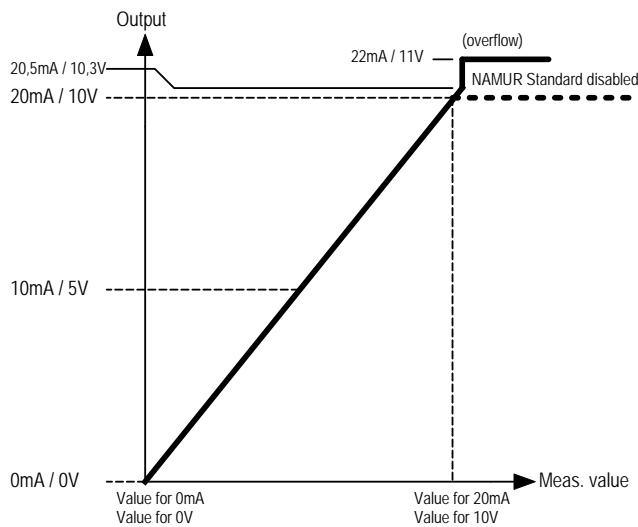

Output behaviour 0-20 mA and 0-10 V

10.6.2.3 Activation of behaviour according to NAMUR recommendation NE43

For all analogue outputs (current and voltage), the output behaviour can be activated according to NAMUR recommendation NE43. When the function is activated, e.g. the linear output of the 4 to 20 mA signals to 3.8 to 20.5 mA. Above 20.5 mA, the current value jumps to approx. 22 mA to signalise a measuring range overshoot. Current output values between 3.8 and 4.0 mA indicate that the measuring range is undershot. The output of approximately 3.6 mA signals a device or process fault (e.g., empty tube signalling).

10.6.3 Pulse output

MIM flowmeter provides a scalable pulse output. When the pulse output is activated, the cyclically incoming volume is available as a pulse train at the output. The pulse width of the pulse output is constant and can be set in a range of 1 ms up to 20 s. The pulse output is updated in a cycle of 20 ms. At the beginning of each update, it is determined how much volume has been accumulated during the previous update period. According to this amount and the set pulse volume, the corresponding amount of pulses is available as a pulse train at the output.



The pulse signal is not suitable for determining the volume flow with an external frequency measurement.



The reaction time of the pulse output is directly dependent on the flow parameter "separation" (cutoff). The shortest reaction time is reached if this parameter is set to the value "0.0" (factory setting: start of measuring range).

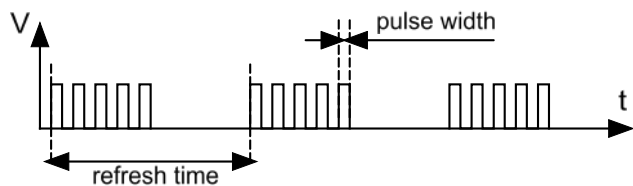

The electrical output type of the pulse output is push-pull, therefore HIGH and LOW are actively switched through at the output.

Pulse output function with different totalizer types

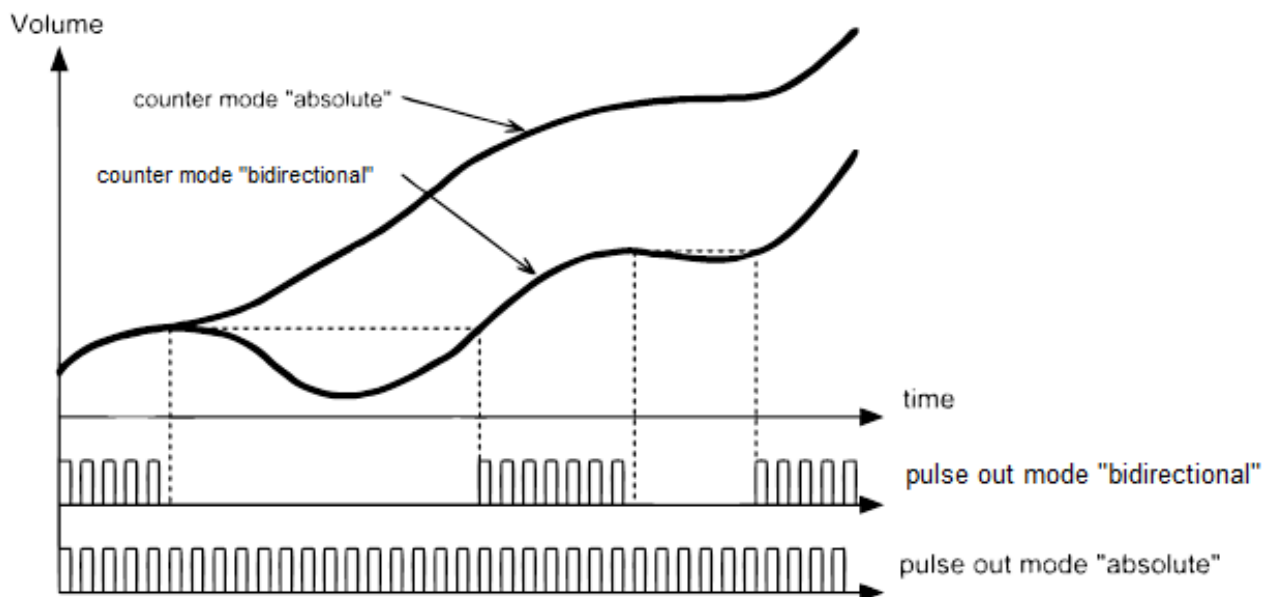

Behavior on OVERFLOW:

If the volumetric flow measurement is in the OVERFLOW range, the pulse output is switched off and a constant HIGH level is applied to the output.

Generation of the output pulse train:

The pulse volume (pulse value volume per output pulse) can be set freely within wide ranges. Together with the adjustable pulse width and the measuring range of the device there is a limited range in which the pulse output is instantaneous.

This is the case if the following condition is met:

$$\frac{\text{MRE-Measurement Range End [L/min]} * \text{pulse width [ms]}}{\text{pulse volume [L]}} \leq 22500$$

or

$$\text{Pulse volume [L]} \geq \frac{\text{MRE-Measurement Range End [L/min]} * \text{pulse width [ms]}}{22500}$$

If the condition is not met, there may be a time lag of the pulse output. This is particularly undesirable if dosing tasks are to be performed with the pulse signal.

The following table shows the different combinations of pulse volume and pulse width for the different measuring ranges, in which the above limiting condition is fulfilled.

Measuring range [LPM]	pulse width [ms]	min. pulse volume [L]	max. pulse rate [pulse/L]
350	20	0.31111	3.21
	10	0.15556	6.43
	5	0.7778	12.86
	1	0.01556	64.29
100	20	0.08889	11.25
	10	0.04444	22.50
	5	0.02222	45.00
	1	0.00444	225.00
50	20	0.04444	22.50
	10	0.02222	45.00
	5	0.01111	90.00
	1	0.00222	450.00
25	20	0.02222	45.00
	10	0.01111	90.00
	5	0.00556	180.00
	1	0.00111	900.00
10	20	0.00889	112.50
	10	0.00444	225.00
	5	0.00222	450.00
	1	0.00044	2250.00
03	20	0.0026	375
	10	0.0013	750
	5	0.0006	1500
	1	0.0001	7500
01	20	0.00089	1125.00
	10	0.00044	2250.00
	5	0.00022	4500.00
	1	0.00004	22500.00

The pulse output only takes place in measuring mode; while the menu mode is active no pulses are given. The pulses accumulated in the menu mode are output as soon as the measuring mode is active again. Depending on the situation, this can also lead to a longer pulse lag.

10.6.3.1 Pulse volume

The parameter "Pulse volume" is defined as volume quantity for the output of a pulse; the unit is corresponding to [volume quantity / pulse]. The likewise common pulse rate [pulse / volume unit] corresponds to the reciprocal of the pulse volume.
Example: Desired pulse rate at the output 10 pulses / liter => pulse volume = 1 / pulse rate = 1/10 L = 0.1 L

10.6.3.2 Volume unit

The volume unit to be set is the input unit for the "Pulse volume" parameter. The definition of a user-defined unit ("user") is also possible and can be programmed in "liters".

Example:

Unit "user" = 10 [L], pulse volume = 2 [user]

The total pulse volume would be 2 * 10 = 20 [L]. After 20 liters, a pulse is output.

10.6.3.1 Pulse width

The pulse width of the pulse output is flexibly adjustable from 1 to 20,000 ms.

10.6.4 Frequency output

The MIM flowmeter provides a scalable frequency output. When this output is activated, the measurement variable (flow or temperature) associated with the frequency output is output proportionally as a frequency with a 1: 1 pulse / pause duration. The output frequency at the end of the measuring range can be set (parameter "maximum frequency"). With the two parameters "Value for 0 Hz" and "Value for max Hz", the frequency output in the measuring range can be freely scaled.

Behavior on OVERFLOW:

If the measured value is in the overflow range, a constant frequency is output.

$$\text{Overflow freq} = \text{max. Freq} + \text{max.Freq} * \text{Overflow} / 100$$

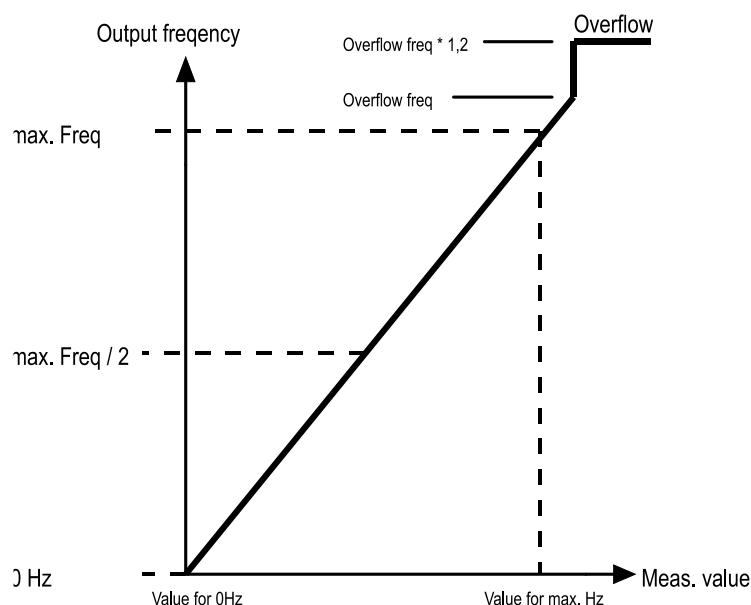

Output behavior Frequency output

10.6.5 Control input

Output 1 can be configured as a control input. This can reset the MIN / MAX memory or the partial quantity counter depending on the assigned measurement variable.

Function	Measurement variable	Control pulse duration
MIN/MAX Reset	Flow, temperature	$0.5s < t_{high} < 4s$
Part volume counter reset	Part volume counter	$0.5s < t_{high} < 4s$

Parameter table **Output 1/2 – Flow**

Sub-parameter level 1	Sub-parameter level 2	Sub-parameter level 3	Description	Value range / value list	Standard value LPM version	Standard value GPM version
<i>disabled</i>			<i>Output deactivated</i>		<i>IO-Link</i>	
Alarm output	Function	<i>List selection</i>	Sets the basic function	<i>Limit function / window function</i>	<i>Limit function</i>	
	Output		Sets the electr. Output	<i>NPN/PNP/PP</i>	<i>NPN</i>	
	switching function		Set the log. switching function	<i>NO/NC</i>	<i>NO</i>	
	threshold	<i>Value input</i>	Sets the switching threshold	<i>MB start ≤ value ≤ Full scale</i>	<i>1</i>	
	lower threshold		Sets the lower threshold for window function	<i>Value threshold ≤ value ≤ MB start</i>	<i>1</i>	
	hysteresis		Defines the switching hysteresis	<i>0 ≤ value ≤ (MB end – MB start)</i>	<i>1</i>	
	filter factor		Factor for the switching delay x100 ms	<i>0x ≤ value ≤ 60x</i>	<i>0</i>	
	direction		Defines the effective direction of the switching delay	<i>Up / Down / Both</i>	<i>Down</i>	
4-20 mA	NAMUR Standard	<i>Value input</i>	Activates the behaviour according to NAMUR NE43	<i>activated / deactivated</i>	<i>deactivated</i>	
	<i>Value 4 mA</i>		Measured value for 4 mA output	<i>MB-start ≤ value ≤ Wert 20 mA</i>	<i>0</i>	
	<i>Value 20 mA</i>		Measured value for 20 mA output	<i>Value 4 mA ≤ value ≤ Full scale</i>	<i>Full scale</i>	
0-20 mA	NAMUR Standard		Activates the behaviour according to NAMUR NE43	<i>activated / deactivated</i>	<i>deactivated</i>	
	<i>Value 0 mA</i>		Measured value for 0 mA output	<i>MB start ≤ value ≤ value 20 mA</i>	<i>0</i>	
	<i>Value 20 mA</i>		Measured value for 20 mA output	<i>Value for 0 mA ≤ value ≤ Full scale</i>	<i>Full scale</i>	
2-10 V	NAMUR Standard		Activates the behaviour according to NAMUR NE43	<i>activated / deactivated</i>	<i>deactivated</i>	
	<i>Value 2 V</i>		Measured value for 2 V output	<i>MB start ≤ value ≤ value 10 V</i>	<i>0</i>	
	<i>Value 10 V</i>		Measured value for 10 V output	<i>Value for 2 V ≤ value ≤ Full scale</i>	<i>Full scale</i>	
0-10 V	NAMUR Standard	Activates the behaviour according to NAMUR NE43	<i>activated / deactivated</i>	<i>deactivated</i>		
	<i>Value 0 V</i>	Measured value for 0 V output	<i>MB start ≤ value ≤ value 10 V</i>	<i>0</i>		
	<i>Value 10 V</i>	Measured value for 10 V output	<i>Value for 0 V ≤ value ≤ Full scale</i>	<i>Full scale</i>		

Sub-parameter level 1	Sub-parameter level 2	Sub-parameter level 3	Description	Value range / value list	Standard value LPM version	Standard value GPM version
Frequency output	<i>max. frequency</i>	<i>Value input</i>	Frequency output at "value at max. Hz"	50-1000 Hz	500 Hz	
	<i>overflow</i>		Overflow value in % of the value "max.frequency"	1-100 [%]	1%	
	<i>Value at 0 Hz</i>		Value at 0 Hz	$MB\ start \leq value \leq value\ at\ max.\ Hz$	0	
	<i>Value at max. Hz</i>		Value at "maximum frequency"	$Value\ for\ 0\ Hz < value \leq Full\ scale$	Full scale	
Control input (only output 1)			Control function for MIN / MAX memory reset	OFF, memory reset	Aus	
KofiCom	<i>Factory calibration mode on output 1</i>					
IO-Link	<i>This mode activates the IO-Link function on output 1 (standard factory setting)</i>					

Parameter table Output 1/2 – Volume

Sub-parameter level 1	Sub-parameter level 2	Sub-parameter level 3	Description	Value range / value list	Standard value LPM version	Standard value GPM version
<i>disabled</i>			<i>Output deactivated</i>		<i>disabled</i>	
Pulse output	Pulse unit	<i>List selection</i>	Sets the Pulse Volume for Pulse Volume	<i>ml, L, m3, galUS, galUK, User</i>	<i>L</i>	<i>galUs</i>
	Pulse volume	<i>value input</i>	Sets the value for the pulse volume	0.001-999	1	
	Pulse width		Sets the pulse width	1-20.000	1 ms	
KofiCom	<i>Factory calibration mode on output 1</i>					
IO-Link	<i>This mode activates the IO-Link function on output 1</i>					

Parameter table Output 1/2 – Temperature

Sub-parameter level 1	Sub-parameter level 2	Sub-parameter level 3	Description	Value range / value list	Standard value LPM version	Standard value GPM version
<i>disabled</i>			<i>Output deactivated</i>		<i>disabled</i>	
Alarm output	Function	<i>List selection</i>	Sets the basic function	<i>Limit function / window function</i>	<i>Limit function</i>	
	Output		Sets the electr. Output	<i>NPN/PNP/PP</i>	<i>NPN</i>	
	Switching function		Sets the log. switching function	<i>NO/NC</i>	<i>NO</i>	
	Threshold		Sets the switching threshold	$MB\ start \leq \mathbf{value} \leq Full\ scale$	<i>1</i>	
	lower threshold		Sets the lower threshold for window function	$Value\ threshold \leq \mathbf{value} \leq MB\ start$	<i>1</i>	
	Hysteresis		Defines the switching hysteresis	$0 \leq \mathbf{value} \leq (MB\ end - MB\ start)$	<i>1</i>	
	Filter factor		Factor for the switching delay x100 ms	$0x \leq \mathbf{value} \leq 60x$	<i>0</i>	
	Direction		Defines the effective direction of the switching delay	<i>Up / Down / Both</i>	<i>Down</i>	
4-20 mA	NAMUR Standard	<i>Value input</i>	Activates the behaviour according to NAMUR NE43	<i>activated / deactivated</i>	<i>deactivated</i>	
	<i>Value 4 mA</i>		Measured value for 4 mA output	$MB\ start \leq \mathbf{value} \leq \mathbf{value}\ 20\ mA$	<i>0</i>	
	<i>Value 20 mA</i>		Measured value for 20 mA output	$Value\ 4\ mA \leq \mathbf{value} \leq Full\ scale$	<i>Full scale</i>	
0-20 mA	NAMUR Standard		Activates the behaviour according to NAMUR NE43	<i>activated / deactivated</i>	<i>deactivated</i>	
	<i>Value 0 mA</i>		Measured value for 0 mA output	$MB\ start \leq \mathbf{value} \leq \mathbf{value}\ 20\ mA$	<i>0</i>	
	<i>Value 20 mA</i>		Measured value for 20 mA output	$Value\ 0\ mA \leq \mathbf{value} \leq Full\ scale$	<i>Full scale</i>	
2-10 V	NAMUR Standard		Activates the behaviour according to NAMUR NE43	<i>activated / deactivated</i>	<i>deactivated</i>	
	<i>Value 2 V</i>		Measured value for 2 V output	$MB\ start \leq \mathbf{value} \leq \mathbf{value}\ 10\ V$	<i>0</i>	
	<i>Value 10 V</i>		Measured value for 10 V output	$Value\ 2\ V \leq \mathbf{value} \leq Full\ scale$	<i>Full scale</i>	
0-10 V	NAMUR Standard		Activates the behaviour according to NAMUR NE43	<i>activated / deactivated</i>	<i>deactivated</i>	
	<i>Value 0 V</i>	Measured value for 0 V output	$MB\ start \leq \mathbf{value} \leq \mathbf{value}\ 10\ V$	<i>0</i>		
	<i>Value 10 V</i>	Measured value for 10 V output	$Value\ 0\ V \leq \mathbf{value} \leq Full\ scale$	<i>Full scale</i>		

Continuation Parameter table **Output 1/2 – Temperature**

Sub-parameter level 1	Sub-parameter level 2	Sub-parameter level 3	Description	Value range / value list	Standard value LPM version	Standard value GPM version
Frequency output	<i>max. frequency</i>	<i>Value input</i>	Frequency output at "value at max. Hz"	50-1000 Hz	500 Hz	
	<i>Overflow</i>		Overflow value in % of the "value at max. frequency"	1-100 [%]	1%	
	<i>Value at 0 Hz</i>		Value at 0 Hz	$MB\ start \leq value \leq value\ for\ max.\ Hz$	0	
	<i>Value at max. Hz</i>		Value at "max. frequency"	$Value\ for\ 0\ Hz < value \leq Full\ scale$	Full scale	
Control input (only OUT1)			Control function for MIN / MAX memory reset	OFF, memory reset	OFF	
KofiCom (only OUT1)	<i>Factory calibration mode on output 1</i>					
IO-Link (only OUT1)	<i>This mode activates the IO-Link function on output 1</i>					

Parameter table **Output 1/2 – Part volume**

Sub-parameter level 1	Sub-parameter level 2	Sub-parameter level 3	Description	Value range / value list	Standard value LPM version	Standard value GPM version
<i>Disabled</i>			<i>Output deactivated</i>		<i>disabled</i>	
Pulse output	Pulse unit	<i>List selection</i>	Sets the Pulse Volume for Pulse Volume	<i>ml, L, m3, galUS, galUK, User</i>	<i>L</i>	<i>galUs</i>
	Pulse volume	<i>Value input</i>	Sets the value for the pulse volume	<i>0-999</i>	<i>1</i>	
	Pulse width		Sets the pulse width	<i>1-20.000</i>	<i>1 ms</i>	
Control input (only Out1)			Control function for counter reset	<i>OFF, memory reset</i>	<i>Off</i>	
KofiCom (only OUT1)	<i>Factory calibration mode on output 1</i>					
IO-Link (only OUT1)	<i>This mode activates the IO-Link function on output 1</i>					

10.7 User service

The user service provides the user with a reset function and password setting. Together with the activation of a user password, therefore, the menu access for the user on the part of a master user can be blocked.

10.7.1 User service / change password

In the factory setting the user password is set to "00000", the user functions are thus freely accessible. If the user password is changed to other than "00000", the password prompt becomes active the next time the user menu is entered. If the set password is no longer known, a master password can be requested from KOBOLD.

10.7.2 User service / factory setting

By activating this function, the user can reset the device to the factory settings. Any user settings will then be lost and the device will be back in delivery condition.

Parameter table **User menu**

Sublevel	Parameter level	Description	Value range / value list	Standard value LPM version	Standard value GPM version
Password	value input	Protects the user service menu by password prompting if the password is not "00000"	<i>00000-99999</i>	<i>00000</i>	
Factory reset	Yes / No	Resets the device to factory settings			
Menu lock	unlocked / closed	<i>With "locked", the menu access only takes place via the password prompt</i>	unlocked / closed	<i>unlocked</i>	
Sim Autostop	Value input	<i>Sets the time for how long the simulation mode remains active</i>	<i>1 - 31 min.</i>	<i>10 min.</i>	

10.8 Service / Factory service

The factory service function is password protected and not accessible to the user.

10.9 Info

10.9.1 General

This info option displays the measuring ranges of the device for flow and temperature.

10.9.2 Version

This info option displays the hardware and software version of the device.

10.9.3 QR code link to the user manual

Here a QR code is displayed. With a suitable smartphone, the code can be scanned and the user manual in English language downloaded directly as a PDF and opened.

The smartphone must have a QR code scanning app and a PDF reader app installed, as well as an internet connection.

Parameter table Info

Menu level	Sublevel	Description
Info	General	Displays the measuring ranges of the device
	Version	Displays the hardware and software version
	Manual	Displays the QR code to download the instruction manual

10.10 Device default settings

The MIM flowmeter is factory set and unloaded with the following configuration:

Display - Dual

Upper display - Flow

Lower display - Temperature

Out 1: **IOLINK**

Out 2: **OFF**

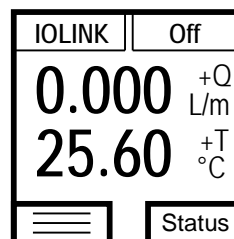

Important note for MIM devices powered with software REV190320:

If output 1 should be operated as a current output, the conversion of the output from IOLINK (factory setting) to current output must be made before the electrical connection of the current loop. If this is not observed, the access to the menu function is blocked and the device can no longer be configured.

11. Status

The electromagnetic flowmeter can detect and display various device or application errors.

If there is a status or error message, the STATUS symbol in the display alternately flashes orange / red. To call up the status / error information, the status key must be pressed, then the status window that appears then lists all the messages that have accumulated up to this point in time. By pressing the $\cdot \leftarrow \leftarrow \leftarrow \cdot$ key, the user confirms the knowledge of the displayed errors, the status memory is cleared and the status window is closed. If one of the displayed errors persists, it will be reported again by flashing the status icon.

The following status / error messages are generated:

Display text	Description	Debugging
<i>Empty Pipe</i>	Measuring tube is not completely filled with medium or medium with too low conductivity is used.	Check the filling of the measuring circuit or conductivity of the medium (> 20 $\mu\text{s} / \text{cm}$)
<i>Temp Sens Error</i>	Error in the temperature measuring circuit	Repair by KOBOLD Service necessary
<i>Meas saturated</i>	Flow measuring circuit overdriven	Reduce flow rate
<i>No Subslave</i>	Internal hardware error	Repair by KOBOLD Service necessary
<i>Simulation</i>	Simulation function active	-

12. Dosing function

The standard MIM provides a simple dosing function. This can be permanently activated or deactivated in the settings menu under the menu item "dosing". If the dosing function is activated, fixed functions are assigned to the 2 outputs which cannot be changed as long as the dosing function is activated:

OUT2 (Pin 2): Dosing output in push pull configuration
 OUT1 (Pin 4): Control input for START/STOP/RESET function



Attention!

When the control input is used, then OUT1 (connection pin 4) must be always polarised, either to the 24 Vdc or to the GND (pin 3). When using a mechanical button that switches the supply voltage to the control input, a 10 kOhm pull-down resistor is recommended. The control input must not be left open!

If the dosing function is deactivated, both outputs are switched to OFF (deactivated) by default, but can then be freely configured again.

Dosing Edit Menu

Main Display Dosing

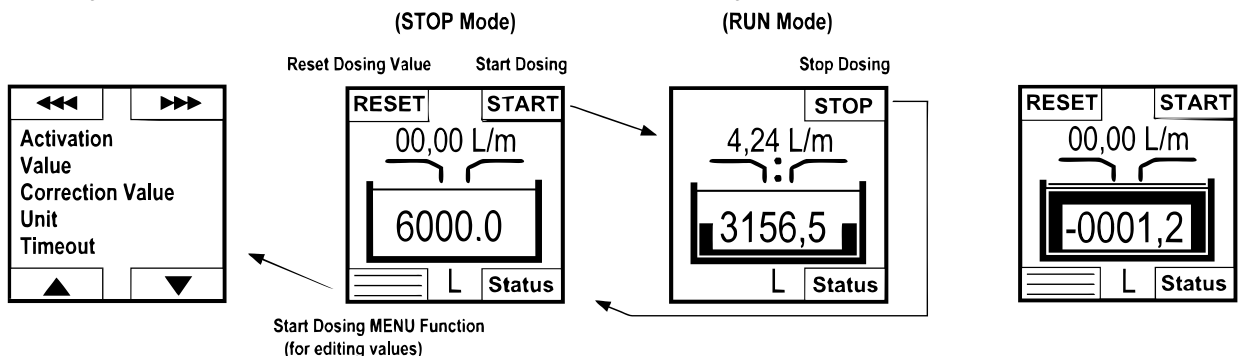

In the main display of the dosing function, the quantity to be dosed in a preselectable unit and the current flow value are displayed on the one hand. The progress of the dosing process is additionally represented by a graphic animation in which the container shown fills in percent and also overflow is shown.

Softkey buttons: All softkey buttons in dosing mode must be held down by the user for at least 2 seconds and then released again for the corresponding function to be triggered. This is to avoid accidental operation.

Control input: Connection OUT1 can be used as a control input for the functions Start / Stop / Reset when the dosing function is activated.

Function	Conditions	Control pulsetime
START	Stop Modus	$0.5\text{ s} < t_{\text{high}} < 4\text{ s}$
STOP	Run Modus	$0.5\text{ s} < t_{\text{high}} < 4\text{ s}$
RESET	Stop Modus	$t_{\text{high}} > 5\text{ s}$

START of dosing:

Dosing can be started either by triggering the "START" softkey or by applying a high pulse to the control input.

After the START function has been triggered, the dosing output is switched to active (High) and the dosing counter is counted down in the standard direction when flow is present.

If the dosing process is stopped incompletely by hand, it can be restarted by the START function.

STOP of dosing

If the dosing process is started, it can be stopped or interrupted by the STOP function. Resumption of dosing to reach the total dosing quantity is possible by START.

Like the START function, the STOP function can be remotely controlled by the control input.

RESETTING the dosing value

If the dosing process is finished or stopped, the dosing quantity can be reset to the default value by the function RESET.

This function can also be triggered at the control input.

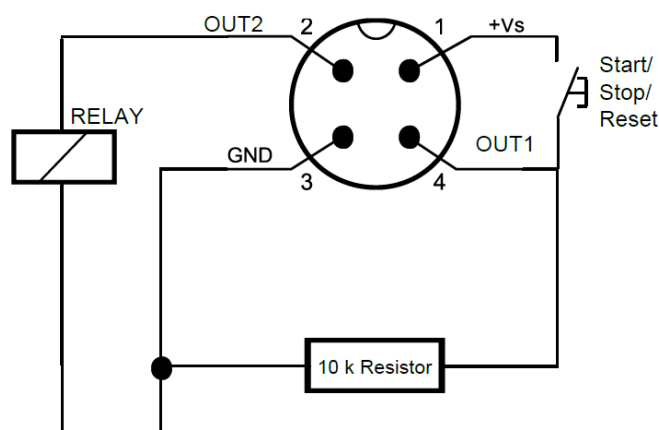
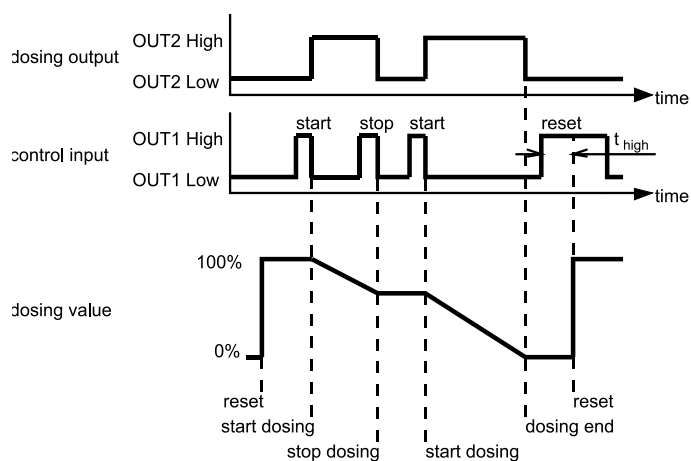

Description of dosing parameters

Dosing quantity "Value"

Parameter "Value" determines the dosing volume. The volume unit is specified in the "Unit" parameter.

The maximum size is limited to 9999.9 (one digit after the decimal point). The absolute quantity can be extended or restricted by a suitable choice of dosing unit.

Dosing unit "Unit"

Parameter "Unit" defines the dosing volume unit. The choices are: mL, L, m3, galUS, galUK, barrel, user

Dosing correction value "Correction value"

The "Correction value" parameter can be used to correct a system-related, constant "incorrect dosing" without having to change the actual dosing quantity. The correction value can be both positive and negative. If the system doses a smaller volume than intended, the correction value must be positive, but negative for a larger real volume. e.g.

Dosing quantity = 10 L

Correction value = -1 L

In this case, the metering counter will count from 10 L to '0', but will stop at 1 L because the quantity to be metered is 9 L calculated on the basis of the correction value of -1 L.

With a correction value of +1 L, the dosing counter will stop counting at -1 L, because the dosing amount is calculated to be 11 L.

$10 - (-1 \text{ L}) = 11 \text{ L}$

The adjustable value of the correction value must always be:

(Value + Correction Value) > 0

If this condition is not met, this will be indicated by a warning message and the correction value will be preset to the value - (Value-0.1).

Dosing parameter "Timeout"

During the dosing process, the presence of a flow value not equal to 0 is constantly monitored. For this purpose, the parameter "Timeout" is used to set the time after which the status message "Time Out" is triggered.

The timeout value can be set between 0.5 sec and 10 sec.

Parameter table **Dosing**

Sublevel	Parameter level	Subparameter level 1	Subparameter level 2	Subparameter level 3	Description	Value range / value list	Standard value LPM version	Standard value GPM version	
Activation	disabled				Dosing function deactivated		disabled		
	activated	Activation			Dosing function activated				
		Value	Value input				$0 \leq \text{Value} \leq 9999.99 [\text{unit}]$	0	
		Correction value	Value input				$-999.99 \leq \text{Value} \leq +999.99 [\text{unit}]$	0	
		Unit	List selection				ml, L, m3, galUS, galUK, User	L	galUs
	Time out	Value input				0.5 - 10 sec	0.5 sec.		

13. IO-Link function

As of firmware version REV190320, the MIM flowmeter has an IO-Link communication interface as standard. Process and diagnostic data can be accessed directly via this interface and the device can be parameterized.

Output 1 is factory configured for IO-Link function. If the IO-Link communication mode is active, the "IOLINK" symbol in the status display for the outputs is displayed in green. The setup menu remains locked when the IOLINK mode is active and is inaccessible.

To ensure that the IO-Link device can be operated correctly on the connected IO-Link master, it is necessary to install the device description file matching the device.

The device description files (IODD) are available in the IODDfinder database under ioddfinder.io-link.com. There may be different IODD versions available for devices of the same type. To select the correct IODD, the device ID can either be read out via the connected IO-Link master or, alternatively, identification can be made using the device's firmware identifier.

The IODD assignment can be found in the following table.

Firmware ID	Product type	Device-ID [hex]	Device-ID [dec]	Remarks
V01.0_Rxxxxxx	-	-	-	No IO-Link function
V01.1_Rxxxxxx	MIM Compact up to 1 inch	0x010100	65792	-
	MIM Compact 2 inch	0x010200	66048	-
	MIM Remote up to 1 inch	0x010300	66304	-
	MIM Remote 2 inch	0x010400	66560	-
V01.11_Rxxxxxx	MIM Compact up to 1 inch	0x010600	67072	-
	MIM Compact 2 inch	0x010700	67328	-
	MIM Remote up to 1 inch	0x010800	67584	-
	MIM Remote 2 inch	0x010900	67840	-

How to download the correct IODD:

- Read out the firmware ID of the device from the INFO menu
- Find out the device ID (decimal) from the table above according to the firmware identification and the product type
- In the IODD finder, identify the correct IODD using the Device ID column and download the associated ZIP file using the download button.

If the device is operated on an IO-Link master with port class A, only a maximum output current of 50 mA may be drawn from output 2 (OUT2) (current or binary output), otherwise the IO-Link master will be overloaded and it can cause malfunctions.

13.1 Specification

Manufacturer	ID 1105 (decimal), 0x0451 (hex)
Manufacturer name	Kobold Messring GmbH
IO-Link specification	V1.1
Bitrate	COM3
Minimum cycle time	1.1 ms
SIO mode	yes (OUT1 in configuration IO-Link)
Block parameterisation	yes
Ready for operation	10 sec.
Max. cable length	20 m
IO-Link master port class	A

14. Technical Information

Measurement process:	electromagnetic
Range:	see order details
Media:	conductive fluids
Minimum conductivity:	≥20 µS/cm
Max. medium viscosity:	70 mm ² /s
Max. pressure:	16 bar
Accuracy:	<±(0.8% of reading+0.5% of full scale)*
Repeatability:	±0.2% of full scale
Response time flow t ₉₀	
(alarm/pulse/frequency output):	<100 ms
(analogue output):	<1 s

Temperature measurement

Sensor:	PT1000
Accuracy:	≤±2 °C (flow >0.2 m/s)
Measuring range:	temperature range of medium
Response time of temperature t ₉₀	
(signal output):	<20 s
Mounting position:	in all directions
In-/outlet:	3 x DN/2 x DN
Pressure drop (max at ME)	MB 01 110 mbar MB 05 400 mbar MB 10 50 mbar MB 15 250 mbar (¾"), 30 mbar (1") MB 20 110 mbar MB 40 450 mbar MB 35 120 mbar
Handling:	4 optical touch fields, useable with hand gloves**
Housing:	stainless steel 1.4404, display screen PMMA

Wetted parts

The wetted parts of MIM-13*** are in conformance with DVGW 270 and WRAS guidelines for drinking water approval.

*** except G9/N9

Connection fitting and housing:	stainless steel 1.4404
Insulation parts:	PEEK
Electrodes:	stainless steel 1.4404
Seals:	FKM: MIM-12xxx; EPDM: MIM-13xxx
Protection:	IP 67

Temperature ranges

Design	Electronic	Model	Seals material	Media temperature	Ambient temperature
compact version	C3T	MIM-12 MIM-13	FKM	-20 °C ... +70 °C ²⁾	-20 °C ... +60 °C
			EPDM		
remote version (PVC cable)	P02 ¹⁾	MIM-12 MIM-13	FKM	-20 °C ... +85 °C	-20 °C ... +60 °C (display electronic)
			EPDM		-20 °C ... +85 °C (sensor)
remote version (ETFE cable)	E02 ¹⁾	MIM-12	FKM	-20 °C ... +140 °C	-20 °C ... +60 °C (display electronic)
			EPDM		-20 °C ... +140 °C (sensor)
		MIM-13	FKM	-40 °C ... +140 °C	-20 °C ... +60 °C (display electronic)
			EPDM		-40 °C ... +140 °C (sensor)

¹⁾ Cable length 02=2m, 05=5m, 10=10m, 15=15m, 20=20m

²⁾ Continuous -20 °C...+70 °C, short term up to max. +85 °C (for max. 60 minutes at max. 40 °C ambient temperature and repetition earliest after 4 hours). Use of the electrical outputs remains limited to temperature range -20 °C ... +70 °C.

Electrical data

Supply voltage:	19 - 30 VDC, internal power consumption max. 200 mA (without outputs)
Display:	TFT display, 128 x 128 pixels, 1.4" display orientation in 90° steps adjustable
Display repetition rate:	0.5 ... 10 s, adjustable
Pulse output	Push-Pull, freely scalable, configurable for partial or accumulated totalizer
Frequency output	Push-Pull, freely scalable, Overflow frequency adjustable
Alarm output:	NPN, PNP, Push-Pull, configurable max. 30 V _{DC} , max. 200 mA short-circuit proof
Analogue output:	active, 3 wire, 0(4)-20 mA, max. load 500 Ω or 0-10 VDC, (R _i = 500 Ω)
Control input (MIN / MAX / partial volume RESET)	OUT1, high active 0 < U _{Low} < 10 VDC 15 VDC < U _{High} < V _s No internal pull-ups available, active high / low signal necessary!
Total and partial quantity counter:	overflow (reset) at 15 * 10 ⁶ liters (regardless of the set unit)
Electrical connection:	plug M12x1, 4-pin

Dosing Function:

MIM-

Dosing value: 0.1 ...9999.9 [Unit]
Dosing output: OUT2
Control input: PushPull, High active
OUT1, High active
 $0 < U_{Low} < 10 V_{DC}$
 $15 V_{DC} < U_{High} < V_s$
No internal pull-ups available,
active high / low signal necessary!
START/STOP pulse: $0.5 \text{ s} < t_{high} < 4 \text{ s}$
RESET pulse: $t_{high} > 5 \text{ s}$

* Under reference conditions: media temperature: 15 °C ... 30 °C, 1 cSt, 500 µS/cm, 1 bar
ambience temperature: 15 °C ... 30 °C
** Limited functionally with black rubber gloves

Pressure Loss

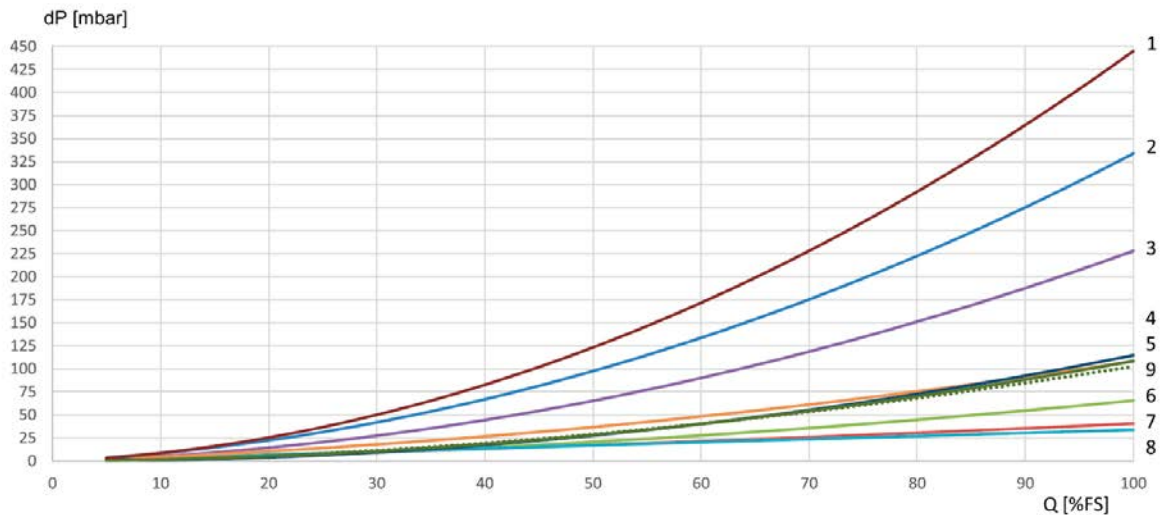

- ① MIM-1x40xx9
- ② MIM-1x05xx4
- ③ MIM-1x15xx5
- ④ MIM-1x35xx9
- ⑤ MIM-1x20xx6
- ⑥ MIM-1x10xx5
- ⑦ MIM-1x03xx4
- ⑧ MIM-1x15xx6
- ⑨ MIM-1x01xx3

15. Order Codes

Order Details (Example: MIM-12 15G G5 C3T 0)

Model	Range	Connection	Electronics	Special version
MIM-12= housing/ electrode VA, FKM seal	01H ¹⁾ = 0.01...1 l/min 01G ²⁾ = 0.16...16 GPH	G2 = G ¼ male	C3T = compact, TFT display, 2 outputs (current/voltage/pulse/ frequency/alarm output configurable), M12x1 plug	0 = without K ⁵⁾ = incl. calibration report
	03H ¹⁾ = 0.03...3 l/min 05H ¹⁾ = 0.04... 10 l/min	G4 ⁴⁾ = G ½ male		
	03G ²⁾ = 0.48...48 GPH 05G ²⁾ = 0.01 ... 2.6 GPM	N4 ⁴⁾ = ½" NPT female		
	10H ¹⁾ = 0.1...25 l/min 15H ¹⁾ = 0.2...50 l/min	G5 ⁴⁾ = G ¾ male		
MIM-13 ⁴⁾ = housing/ electrode VA, EPDM seal	10G ²⁾ = 0.025...6.6 GPM 15G ²⁾ = 0.05...13 GPM	N5 ⁴⁾ = ½" NPT female	P02 ³⁾ = remote version TFT display, 2 m PVC cable, max. 85 °C	
	15H ¹⁾ = 0.2...50 l/min 20H ¹⁾ = 0.4 ... 100 l/min	G6 ⁴⁾ = G 1 male		
	15G ²⁾ = 0.05...13 GPM 20G ²⁾ = 0.1...26 GPM	N6 ⁴⁾ = ½" NPT female	E02 ³⁾ = remote version, TFT display, 2 m ETFE cable, max. 140 °C	
	35H ¹⁾ = 1.5...350 l/min 40H ¹⁾ = 3 ... 650 l/min	G9 = G 2 male		
	35G ²⁾ = 0.4...90 GPM 40G ²⁾ = 0.8 ... 170 GPM	N9 = 2" NPT female		

1) l/min-package (nameplate (l/min, °C, bar)), calibrated range and temperature °C

2) GPM-package (nameplate (GPM, °F, PSI)), calibrated range and temperature °F



3) Cable length 02 = 2 m, 05 = 5 m, 10 = 10 m, 15 = 15 m, 20 = 20 m. Wall mounting brackets (brackets incl. accessories) is included in the scope of delivery.

4) Regulation (EC) No. 1935/2004 for materials and articles intended to come into contact with food. Not for connection code G9/N9.

5) Please specify number of measuring points in clear text.

Accessories

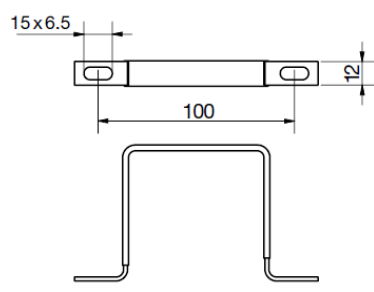
Description	Model	Image
Stainless steel wall mounting kit for remote version (2 brackets, without nuts/washers)	ERS-ZOK-023618	

Description	Model	Dimensions [mm]	Image
Clamping bracket set for wall mounting (stainless steel with partial polyolefin sleeve)	ZUB-MIM225128		

Order Details MIM Fitting Sets Accessory Kits*

Accessory kit number	Meter connection	Process connection	Fitting set type
ZUB-AD2U15P08	G ½ cap nut	¼" NPT male	Cap nut and union
ZUB-AD2G08P08	G ¼ female	¼" NPT male	Cap nut and union
ZUB-AD2G15P15	G ½ female	½" NPT male	Adapter
ZUB-AD2G15N08	G ½ female	¼" NPT female	Adapter
ZUB-AD2G15N15	G ½ female	½" NPT female	Adapter
ZUB-AD2U20P15	G ¾ cap nut	½" NPT male	Cap nut and union
ZUB-AD2G20P20	G ¾ female	¾" NPT male	Adapter
ZUB-AD2G20N15	G ¾ female	½" NPT female	Adapter
ZUB-AD2G20N20	G ¾ female	¾" NPT female	Adapter
ZUB-AD2U25P15	G 1 cap nut	½" NPT male	Cap nut and union
ZUB-AD2U25P20	G 1 female	¾" NPT male	Cap nut and union
ZUB-AD2G25N15	G 1 female	½" NPT female	Adapter
ZUB-AD2G25N20	G 1 female	¾" NPT female	Adapter
ZUB-AD2G25N25	G 1 female	1" NPT female	Adapter
ZUB-AD2G25T25	G 1 female	1" Tri-Clamp®	Adapter
ZUB-AD2G50T50	G 2 female	2" Tri-Clamp®	Adapter

* **Note:** All fitting kits include 2x Klinger SIL® flat sealing gaskets or 2 x FKM O-rings (for ZUB-AD2G50T50)

16. Dimensions

[mm]

Compact version

G
¼
½
¾
1

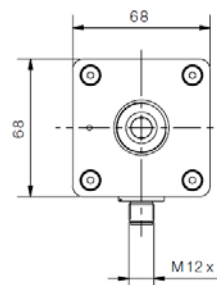
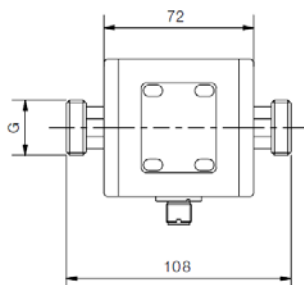

NPT
½
¾
1

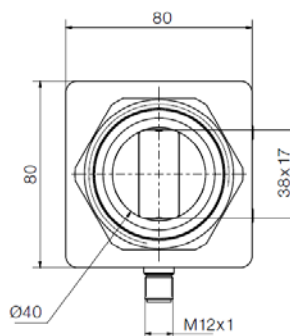
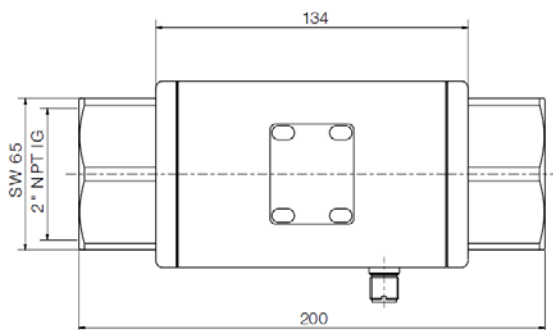
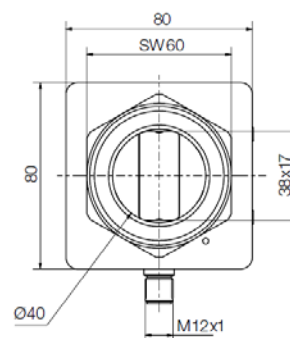
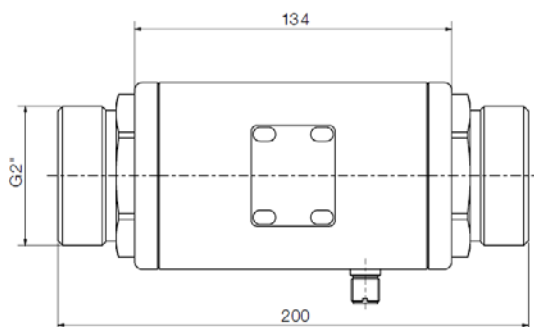
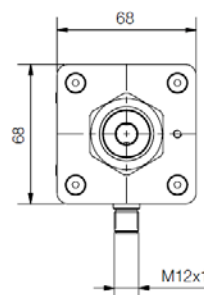
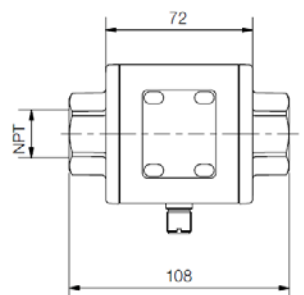

MIM-

Remote version

Without wall mounting brackets

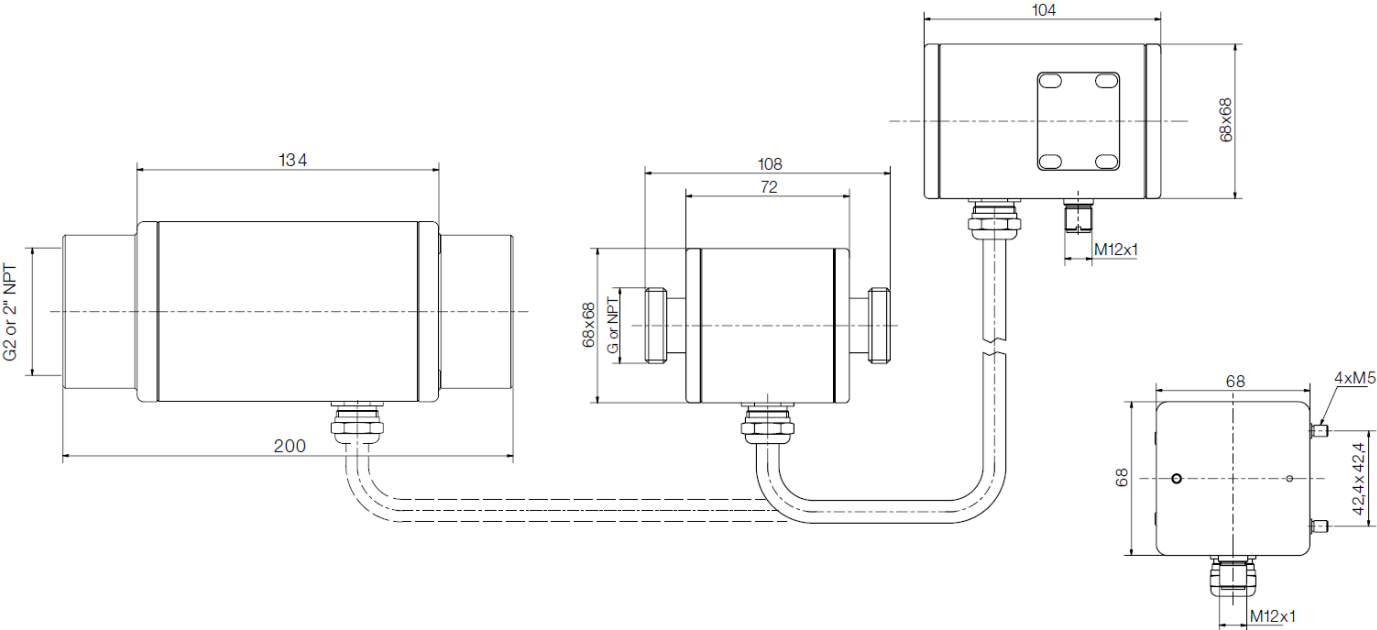

With wall mounting brackets

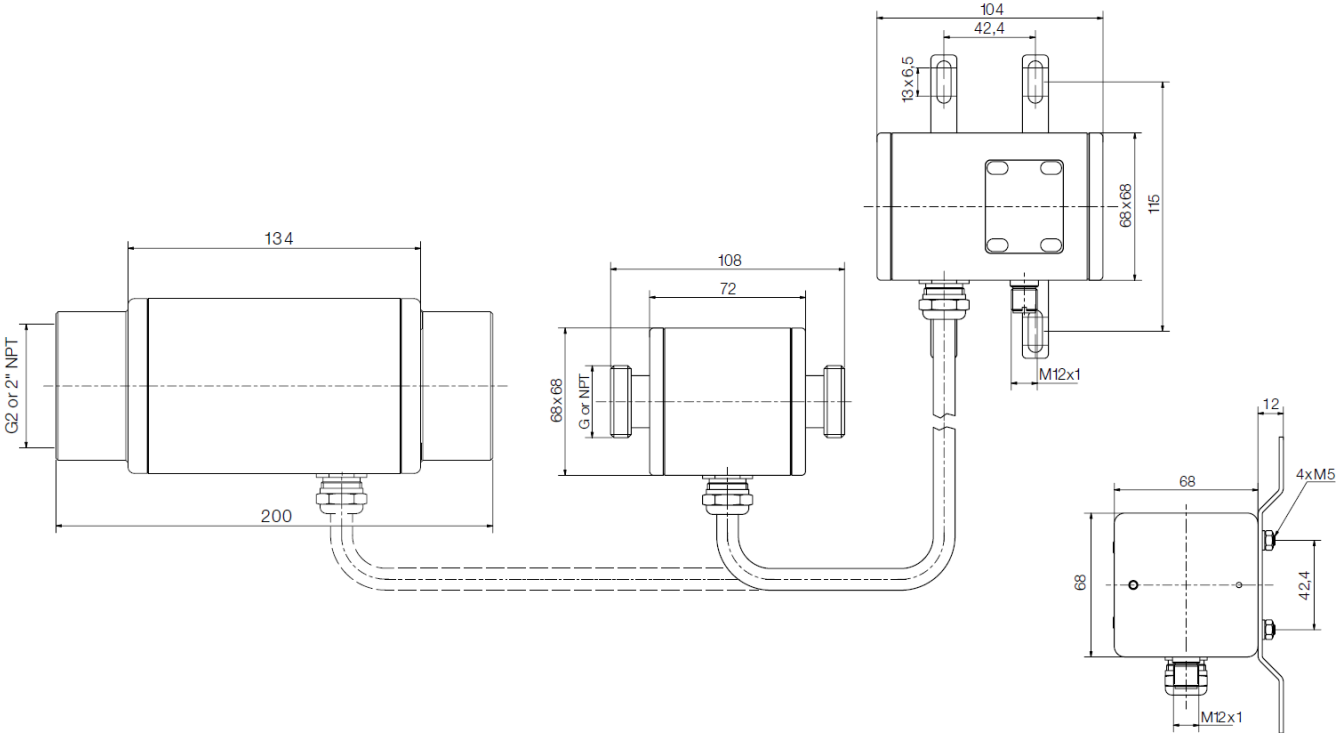

17. Disposal

Note!

- Avoid environmental damage caused by media-contaminated parts
- Dispose of the device and packaging in an environmentally friendly manner
- Comply with applicable national and international disposal regulations and environmental regulations.

Batteries

Batteries containing pollutants are marked with a sign consisting of a crossed-out garbage can and the chemical symbol (Cd, Hg, Li or Pb) of the heavy metal that is decisive for the classification as containing pollutants:

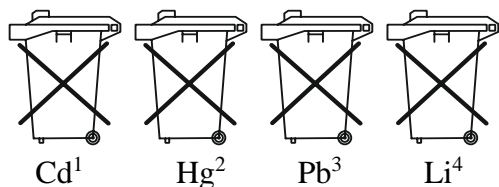

1. „Cd" stands for cadmium
2. „Hg" stands for mercury
3. „Pb" stands for lead
4. „Li" stands for lithium

Electrical and electronic equipment



18. Appendix

18.1 IO-Link process data structure

Process data length: 9 bytes

Byte no.	Data	Bit count	Format	Factor	Range	Value
0 - 2	Flow	24 Bit	IntegerT	1/1000	+/-8388,608	L/min
3 - 6	Volume	32 Bit	FloatT		+/-1,4*10 ⁻⁴⁵ ... +/-3,4*10 ⁺³⁸	L
7 - 8	Temperature	12 Bit	IntegerT	1/10	+/-204,8	°C
	reserved	1 Bit	BooleanT			
	reserved	1 Bit	BooleanT			
	Status OUT1	1 Bit	BooleanT			
	Status OUT2	1 Bit	BooleanT			

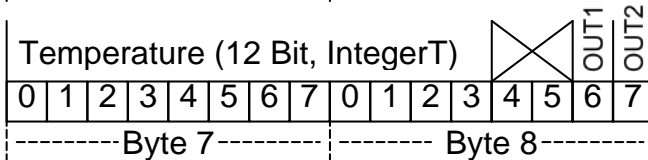
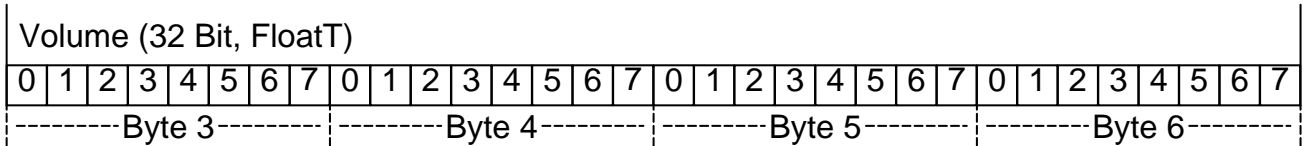
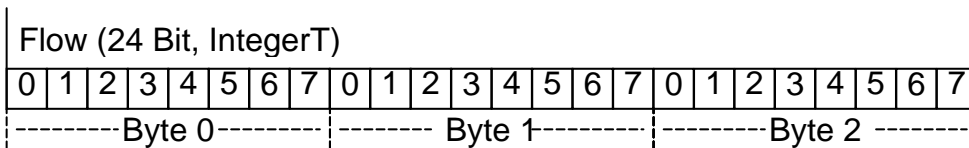

18.2 IO-Link diagnosis information

Event Code [hex]	Event Code [dec]	Name	Device Status	Type	Definition
0x7710	30480	Short Circuit		Error	check installation
0x8C10	35856	Process Variable Range Overrun		Warning	process data uncertain
0x8C20	35872	Measurement Range Overrun		Error	check application
0x8C30	35888	Process Variable Range Underrun		Warning	process data uncertain
0x1838	6200	1. Test Event For Protocol Testing		Error	first test event
0x1839	6201	2. Test Event For Protocol Testing		Error	second test event
0x183A	6202	Flow MRE Overrun		Warning	flow measuring range overrun
0x183B	6203	Flow MRS Underrun		Warning	flow measuring range underrun
0x183C	6204	Flow Overflow Overrun	2	Warning	flow overflow range overrun
0x183D	6205	Flow Underflow Underrun	2	Warning	flow underflow range underrun
0x183E	6206	Flow Cutoff Out		Warning	out of flow cutoff range
0x183F	6207	Temperature MRE Overrun		Warning	temperature measuring range overrun
0x1840	6208	Temperature MRS Underrun		Warning	temperature measuring range underrun
0x1841	6209	Temperature Overflow Overrun	2	Warning	temperature overflow range overrun
0x1842	6210	Temperature Underflow Underrun	2	Warning	temperature underflow range underrun
0x1843	6211	NVM Error	4	Error	non-volatile memory is corrupt
0x1844	6212	Subslave Lost		Error	communication to subs slave interrupted
0x1845	6213	Subslave Not Found	4	Error	communication to subs slave couldn't be established
0x1846	6214	Empty pipe		Warning	no media in tube
0x1847	6215	Temperature Sensor Error	4	Error	no sensor attached
0x1848	6216	Measuring Circuit Saturated	2	Warning	ADC out of range
0x1849	6217	Counter Overflow	2	Error	volume or part volume counter overflowed

Event Code [hex]	Event Code [dec]	Name	Device Status	Type	Definition
0x184A	6218	Dosing Timeout		Warning	indicates that the no flow timeout of the dosing function is active
0x184B	6219	Simulation Active		Warning	indicates that one of the simulations is running

Diagnostic information is sent to the IO-Link master by event in IO-Link mode and, in contrast to the status display in standard device mode, does not remain persistent.

18.3 IO-Link system command table

Command (hex)	Command (dec)	Command name
0x82	130	Restore factory settings
0xA0	160	Reset part volume counter
0xA1	161	Start flow simulation
0xA2	162	Stop flow simulation
0xA3	163	Start temperature simulation
0xA4	164	Stop temperature simulation
0xA5	165	Start part volume simulation
0xA6	166	Stop part volume simulation
0xA7	167	Events Handling ON
0xA8	168	Events Handling OFF
0xA9	169	Reset MinMax for Flow
0xAA	170	Reset MinMax for Temperature

18.4 IO Link ISDU parameter table

Parameters relating to the measured values flow, temperature or volume must be entered in the basic units and, if necessary, converted beforehand. The basic units are:

Flow: **L/min**

Temperature: **°C**

Volume: **liters**

Units conversion table

Category: Flow		
Unit	description	conversion
L/m	Liters per minute (basic unit)	-
L/h	Liters per hour	1 L/h = 0.0167 L/m
mL/m	Milliliters per minute	1 mL/m = 0.001 L/m
m ³ /h	Cubic meters per hour	1 m ³ /h = 16.667 L/m
gal/m	US gallons per minute	1 gal/m = 3.7854 L/m
gal/h	US gallons per hour	1 gal/h = 0.06309 L/m
galk/m	UK gallons per minute	1 galk/m = 4.54609 L/m
galk/h	UK gallons per hour	1 galk/h = 0.07577 L/m
L/s	Liters per second	1 L/s = 60 L/m
mL/s	Milliliters per second	1 mL/s = 0.0000167 L/m
USER	user unit	1 user unit = USER * L/m

Category: Temperature		
Unit	description	conversion
°C	degree Celsius (basic unit)	-
°F	degree Fahrenheit	$x \text{ °C} = (32 + x * 1,8) \text{ °F}$
USER	user unit	1 user unit = USER * °C

Category: Volume		
Unit	description	conversion
L	Liters (basic unit)	-
mL	Milliliters	1 mL = 0.001 L
m ³	Cubik meters	1 m ³ = 1000 L
galUS	US gallons	1 galUS = 3.7854 L
galUK	UK gallons	1 galk = 4.54609 L
barrel	Barrel (US)	1 barrel = 158.99 L
USER	user unit	1 user unit = USER * L

MIM-

Index [hex]	Name	Description	Factory default	Max Value	Min Value	Length [Bytes]	Data Type	Access
System								
0x0002	SystemCommand	See Table "Comand Codes"				1	UIntegerT	W
Product Identification (Vendor specific parameters)								
0x0010	VendorName		Kobold Messring			max. 20	StringT	R
0x0011	VendorText		www.kobold.com			max. 32	StringT	R
0x0012	ProductName		MIM-XXXXXXXXXX			max. 16	StringT	R
0x0013	ProductID		[exact model code]			max. 16	StringT	R
0x0014	ProductText		magnetic inductive flow meter			max. 32	StringT	R
0x0015	Serialnumber	only read parameter				max. 8	StringT	R
0x0016	HardwareRevision					max. 8	StringT	R
0x0017	FirmwareRevision	Firmware Revision is constant in FW				max. 8	StringT	R
0x0018	ApplicationDevice Tag	tag name is from user configurable				32	StringT	R/W
0x0019	FunctionTag	function tag is from user configurable				32	StringT	R/W
0x0020	LocationTag	location tag is from user configurable				32	StringT	R/W

Index [hex]	Name	Description	Factory default	Max Value	Min Value	Length [Bytes]	Data Type	Access
Device Status Information								
0x0024	DeviceStatus	0 - Device OK 1 - Maintenance required 2 - Out of specification 3 - Functional check 4 - Failure				1	UIntegerT	R
0x0025	DetaildDevice Status					max. 20	ArrayT of OctetStringT 3	R
Display Configuration								
0x0100	DisplayOrientation	Orientation of display	1	(0) - Landscape (1) - Portrait Flip (2) - Landscape Flip (3) - Portrait		1	UIntegerT	R/W
0x0103	DisplayLayout	Single or dual layout	1	(0) - single (1) - dual		1	UIntegerT	R/W
0x0104	UpperDisplay	Source for the upper display	0	(0) - Flow (1) - Volume (2) - Temperature (3) - Part Volume		1	UIntegerT	R/W
0x0105	LowerDisplay	Source for the lower display	2	(0) - Flow (1) - Volume (2) - Temperature (3) - Part Volume		1	UIntegerT	R/W
0x0106	DisplayRefresh Time	Refresh intervall for the display [s]	0,5	10,0	0,5	4	FloatT	R/W
0x010A	LeftHotkey Function	Function for left hotkey	0	(0) - Off (1) - Value (2) - MinMax		1	UIntegerT	R/W
0x010B	RightHotkey Function	Function for right hotkey	0	(0) - Off (1) - Value (2) - MinMax		1	UIntegerT	R/W
0x010C	LeftHotkeySource	Source for the left hotkey	0	(0) - Flow (1) - Volume (2) - Temperature (3) - Part Volume		1	UIntegerT	R/W
0x010D	RightHotkeySource	Source for the right hotkey	0	(0) - Flow (1) - Volume (2) - Temperature (3) - Part Volume		1	UIntegerT	R/W
0x010E	SensitivityOptical Keys	Sensitivity for the optical keys	0	(0) - low (1) - middle (2) - high		1	UIntegerT	R/W
0x010F	AutomaticMenu Leave	Automatic menu leaves if the timeout [s] is hit. 0 = timeout not active	0	60	0	1	UIntegerT	R/W

Index [hex]	Name	Description	Factory default	Max Value	Min Value	Length [Bytes]	Data Type	Access
Output 1 (In IO-Link mode output 1 can be parameterized individual, operating mode can only be changed manually)								
0x0112	OUT1AlarmFunction	Limit or window function for the alarm output	0	(0) - Limit (1) - Window		1	UIntegerT	R/W
0x0113	OUT1AlarmOutputType	Alarm output NPN, PNP or Push pull	0	(0) - NPN (1) - PNP (2) - PushPull		1	UIntegerT	R/W
0x0114	OUT1AlarmSwitchFunction	Alarm output normally opened or closed	0	(0) - normally opened (1) - normally closed		1	UIntegerT	R/W
0x0115	OUT1AlarmThreshold	Threshold for the alarm output [LPM/°C]	1,0	MRE	MRS	4	FloatT	R/W
0x0119	OUT1AlarmLowerThreshold	Threshold for the alarm output used by the window function [LPM/°C]	1,0	OUT1AlarmThreshold	MRS	4	FloatT	R/W
0x011D	OUT1AlarmHysteresis	Switching hysteresis for the alarm output [LPM/°C]	1,0	0	MBE - MBS	4	FloatT	R/W
0x0121	OUT1AlarmSuppressionFactor	How many times the threshold must be hit in order to switch the alarm output	0	60	0	1	UIntegerT	R/W
0x0122	OUT1AlarmSuppressionDirection	for which direction the suppression factor is used	0	(0) - Up (1) - Down (2) - Both		1	UIntegerT	R/W
0x0123	OUT1AnalogNamurStandard	If enabled (1) the analog output conforms with the NAMUR Standard NE42. If disabled (0) the analog output stays in his equivalent range (e.g. 4-20mA)	1	(0) - NAMUR disabled (1) - NAMUR enabled		1	UIntegerT	R/W
0x0124	OUT1AnalogValue0mA	The value from the slot used for the 0mA scaling point [LPM/°C]	0,0	OUT1AnalogValue20mA	MRS	4	FloatT	R/W

Index [hex]	Name	Description	Factory default	Max Value	Min Value	Length [Bytes]	Data Type	Access
0x0128	OUT1AnalogValue 4mA	The value from the slot used for the 4mA scaling point [LPM/°C]	0,0	OUT1 Analog Value20mA	MRS	4	FloatT	R/W
0x012C	OUT1AnalogValue 20mA	The value from the slot used for the 20mA scaling point [LPM/°C]	100,0	MRE	OUT1 Analog Value0mA	4	FloatT	R/W
0x0130	OUT1AnalogValue 0V	The value from the slot used for the 0V scaling point [LPM/°C]	0,0	OUT1 Analog Value10V	MRS	4	FloatT	R/W
0x0134	OUT1AnalogValue 2V	The value from the slot used for the 2V scaling point [LPM/°C]	0,0	OUT1 Analog Value10V	MRS	4	FloatT	R/W
0x0138	OUT1AnalogValue 10V	The value from the slot used for the 10V scaling point [LPM/°C]	100,0	MRE	OUT1Analog Value0V	4	FloatT	R/W
0x013C	OUT1PulseVolume	The volume represented by one pulse [L]	1,0	999,999	0,000001	4	FloatT	R/W
0x0140	OUT1PulseVolume Unit	Unit used for the pulse output	1	(0) - USER (1) - L (2) - mL (3) - m3 (4) - galUS (5) - galUK (6) - Barrel		1	UIntegerT	R/W
0x0141	OUT1PulseVolume UnitUser	User Unit used for the pulse output [L]	1,0	9999,9	0,0	4	FloatT	R/W
0x0145	OUT1PulseWidth	Width of each pulse [ms]	1	20000	1	2	UIntegerT	R/W
0x0147	OUT1Frequencyat FS	Max. frequency in Hz for the output [Hz]	500	1000	50	2	UIntegerT	R/W
0x0149	OUT1Frequency Overflow	Overflow frequency in percent of the max frequency [%]	1	100	0	1	UIntegerT	R/W
0x014A	OUT1Frequency Value0Hz	Value from source used for 0 Hz scaling point [LPM/°C]	0,0	OUT1 Frequency ValueMax Hz	MRS	4	FloatT	R/W
0x014E	OUT1Frequency ValueMaxHz	Value from source used for max. Hz scaling point [LPM/°C]	100,0	MRE	OUT1 Frequency Value0Hz	4	FloatT	R/W

MIM-

Index [hex]	Name	Description	Factory default	Max Value	Min Value	Length [Bytes]	Data Type	Access
0x0152	OUT1CtrlFunction	Control input function -> Off or Memory reset	0	(0) - Off (1) - Memoryreset		1	UIntegerT	R/W
Output 2								
0x0163	OUT2Source	Source for the output	0	(0) - Flow (1) - Volume (2) - Temperature (3) - Part Volume		1	UIntegerT	R/W
0x0164	OUT2Type	Configuration of the output -> 0-20mA, Pulse, Frequency, etc.	0	(0) - disabled (1) - Alarm Output (2) - 4-20mA (3) - 0-20mA (4) - 2-10V (5) - 0-10V (6) - Pulse Output (7) - Frequency Output		1	UIntegerT	R/W
0x0165	OUT2Alarm Function	Limit or window function for the alarm output	0	(0) - Limit (1) - Window		1	UIntegerT	R/W
0x0166	OUT2AlarmOutput Type	Alarm output NPN, PNP or Push pull	0	(0) - NPN (1) - PNP (2) - PushPull		1	UIntegerT	R/W
0x0167	OUT2AlarmSwitchFunction	Alarm output normally opened or closed	0	(0) - normally opened (1) - normally closed		1	UIntegerT	R/W
0x0168	OUT2Alarm Threshold	Threshold for the alarm output [LPM/°C]	1,0	MRE	MRS	4	FloatT	R/W
0x016C	OUT2AlarmLower Threshold	Threshold for the alarm output used by the window function [LPM/°C]	1,0	OUT2Alarm Threshold	MRS	4	FloatT	R/W
0x0170	OUT2Alarm Hysteresis	Switching hysteresis for the alarm output [LPM/°C]	1,0	0	MBE - MBS	4	FloatT	R/W
0x0174	OUT2Alarm SuppressionFactor	How many times the threshold must be hit in order to switch the alarm output	0	60	0	1	UIntegerT	R/W
0x0175	OUT2Alarm Suppression Direction	for which direction the suppression factor is used	0	(0) - Up (1) - Down (2) - Both		1	UIntegerT	R/W

Index [hex]	Name	Description	Factory default	Max Value	Min Value	Length [Bytes]	Data Type	Access
0x0176	OUT2AnalogNamurStandard	If enabled (1) the analog output conforms with the NAMUR Standard NE42. If disabled (0) the analog output stays in his equivalent range (e.g. 4-20mA)	1	(0) - NAMUR disabled (1) - NAMUR enabled		1	UIntegerT	R/W
0x0177	OUT2AnalogValue0mA	The value from the slot used for the 0mA scaling point [LPM/°C]	0,0	OUT2AnalogValue20mA	MRS	4	FloatT	R/W
0x017B	OUT2AnalogValue4mA	The value from the slot used for the 4mA scaling point [LPM/°C]	0,0	OUT2AnalogValue20mA	MRS	4	FloatT	R/W
0x017F	OUT2AnalogValue20mA	The value from the slot used for the 20mA scaling point [LPM/°C]	100,0	MRE	OUT2AnalogValue0mA	4	FloatT	R/W
0x0183	OUT2AnalogValue0V	The value from the slot used for the 0V scaling point [LPM/°C]	0,0	OUT2AnalogValue10V	MRS	4	FloatT	R/W
0x0187	OUT2AnalogValue2V	The value from the slot used for the 2V scaling point [LPM/°C]	0,0	OUT2AnalogValue10V	MRS	4	FloatT	R/W
0x018B	OUT2AnalogValue10V	The value from the slot used for the 10V scaling point [LPM/°C]	100,0	MRE	OUT2AnalogValue0V	4	FloatT	R/W
0x018F	OUT2PulseVolume	The volume represented by one pulse [L]	1,0	999,999	0,000001	4	FloatT	R/W
0x0193	OUT2PulseVolumeUnit	Unit used for the pulse output	1	(0) - USER (1) - L (2) - mL (3) - m3 (4) - galUS (5) - galUK (6) - Barrel		1	UIntegerT	R/W
0x0194	OUT2PulseVolumeUnitUser	User Unit used for the pulse output [L]	1,0	9999,9	0,0	4	FloatT	R/W
0x0198	OUT2PulseWidth	The width of each pulse [ms]	1	20000	1	2	UIntegerT	R/W

MIM-

Index [hex]	Name	Description	Factory default	Max Value	Min Value	Length [Bytes]	Data Type	Access
0x019A	OUT2FrequencyatFS	The max. frequency in Hz for the output [Hz]	500	1000	50	2	UIntegerT	R/W
0x019C	OUT2FrequencyOverflow	The overflow frequency in percent of the max frequency [%]	1	100	0	1	UIntegerT	R/W
0x019D	OUT2FrequencyValue0Hz	The value from the slot used for the 0Hz scaling point [Hz]	0,0	OUT2FrequencyValueMaxHz	MRS	4	FloatT	R/W
0x01A1	OUT2FrequencyValueMaxHz	The value from the slot used for the max Hz scaling point [LPM/°C]	100,0	MRE	OUT2FrequencyValue0Hz	4	FloatT	R/W
Dosing								
0x01B6	DosingValue	Dosing value [L]	0,0	9999,9	0,0	4	FloatT	R/W
0x01BA	DosingCorrectionValue	Correction value which is added to the dosing value for the complete dosing counter [L]	0,0	DosingValue	minus DosingValue	4	FloatT	R/W
0x01BE	DosingUnit	Unit used for the dosing function	1	(0) - USER (1) - L (2) - mL (3) - m3 (4) - galUS (5) - galUK (6) - Barrel		1	UIntegerT	R/W
0x01BF	DosingUnitUser	User Unit used for the dosing function [L]	1,0	9999,9	0,0	4	FloatT	R/W
0x01C3	DosingTimeout	Timeout in seconds for no flow [s]	0,5	10,0	0,5	4	FloatT	R/W
0x01C7	DosingCounter	Saved dosing volume counter stats	0,0	999999,0	-999999,0	4	FloatT	R
Service								
0x01CB	ServiceUserPassword	Password for user service menu and main menu	0	99999	0	4	UIntegerT	R/W

Index [hex]	Name	Description	Factory default	Max Value	Min Value	Length [Bytes]	Data Type	Access
0x01CF	ServiceUserMenu Locked	Whether main menu is locked or not	0	(0) - not locked (1) - locked		1	UIntegerT	R/W
0x01D0	SimulationAuto Stop	Auto stop for Simulation after time [min]	10	31	1	1	UIntegerT	R/W

MIM-

Index [hex]	Name	Description	Factory default	Max Value	Min Value	Length [Bytes]	Data Type	Access
Misc								
0x01D2	LanguageSelection	Language selection	0		(0) - English (1) - German (2) - French (3) - Spanish	1	UIntegerT	R/W
0x0262	OperatingHours Count	Operating hours counter [h]	0	4294967296	0	4	UIntegerT	R
Flow								
0x02F6	CutOff	Cut off for flow value [LPM]	0,0	MRE	0,0	4	FloatT	R/W
0x02FA	Unit	Unit used for flow	1		(0) - USER (1) - L/m (2) - mL/m (3) - L/h (4) - m3/h (5) - galUS/m (6) - galUS/h (7) - galUK/m (8) - galUK/h (9) - L/s (10) - mL/s	1	UIntegerT	R/W
0x02FB	UserUnit	User Unit used for flow [LPM]	1,0	9999,9	0,0	4	FloatT	R/W
0x0314	SimMode	Mode of the Simulation: Static, Triangle or Monotonic	0		(0) - Static (1) - Triangle (2) - Monotonic	1	UIntegerT	R/W
0x0315	SimStartValue	Value to start with the simulation [LPM]	0,0	9999,0	-9999,0	4	FloatT	R/W
0x0319	SimIncrement Value	Incrementation value of the simulation [LPM]	10,0	999,0	-999,0	4	FloatT	R/W
0x031D	SimNumber Intervals	Number of intervals to simulation	20	65000	1	2	UIntegerT	R/W
0x031F	SimTimingIntervals	Timinig in ms between intervals	50	50000	50	2	UIntegerT	R/W
0x0321	ValueInSiUnit	Saved flow value in SI unit [LPM]	0,0	999999,0	-999999,0	4	FloatT	R
0x0325	MinValueInSiUnit	Saved min flow value in SI unit [LPM]	0,0	999999,0	-999999,0	4	FloatT	R

Index [hex]	Name	Description	Factory default	Max Value	Min Value	Length [Bytes]	Data Type	Access
0x0329	MaxValueInSiUnit	Saved max flow value in SI unit [LPM]	0,0	999999,0	-999999,0	4	FloatT	R
Volume								
0x0359	CountingType	counting type for a volume slot -> absolute or bidirectional	0	(0) - absolute (1) - bidirectional		1	UIntegerT	R/W
0x035E	Unit	Unit used for volume	1	(0) - USER (1) - L (2) - mL (3) - m3 (4) - galUS (5) - galUK (6) - Barrel		1	UIntegerT	R/W
0x035F	UserUnit	User Unit used for volume [L]	1,0	9999,9	0,0	4	FloatT	R/W
0x0385	ValueInSiUnit	Saved volume value in SI unit [L]	0,0	999999,0	-999999,0	4	FloatT	R
Temperature								
0x03C2	Unit	Unit used for temperature	1	(0) - USER (1) - °C (2) - °F		1	UIntegerT	R/W
0x03C3	UserUnit	User Unit used for temperature [°C]	1,0	9999,9	0,0	4	FloatT	R/W
0x03DC	SimMode	Mode of the Simulation: Static, Triangle or Monotonic	0	(0) - Static (1) - Triangle (2) - Monotonic		1	UIntegerT	R/W
0x03DD	SimStartValue	Value to start with the simulation [°C]	0,0	9999,0	-9999,0	4	FloatT	R/W
0x03E1	SimIncrement Value	Incrementation value of the simulation [°C]	10,0	999,0	-999,0	4	FloatT	R/W
0x03E5	SimNumber Intervals	Number of intervals to simulation	20	65000	1	2	UIntegerT	R/W
0x03E7	SimTimingIntervals	Timinig [ms] between intervals	50	50000	50	2	UIntegerT	R/W

MIM-

Index [hex]	Name	Description	Factory default	Max Value	Min Value	Length [Bytes]	Data Type	Access
0x03E9	ValueInSiUnit	Saved temperature value in SI unit [°C]	0,0	999999,0	-999999,0	4	FloatT	R
0x03ED	MinValueInSiUnit	Saved min temperature value in SI unit [°C]	0,0	999999,0	-999999,0	4	FloatT	R
0x03F1	MaxValueInSiUnit	Saved max temperature value in SI unit [°C]	0,0	999999,0	-999999,0	4	FloatT	R
Part Volume								
0x0421	CountingType	counting type for a volume slot -> absolute or bidirectional	0	(0) - absolute (1) - bidirectional		1	UIntegerT	R/W
0x0426	Unit	Unit used for part volume	1	(0) - USER (1) - L (2) - mL (3) - m3 (4) - galUS (5) - galUK (6) - Barrel		1	UIntegerT	R/W
0x0427	UserUnit	User Unit used for part volume [L]	1,0	9999,9	0,0	4	FloatT	R/W
0x0440	SimMode	Mode of the Simulation: Static, Triangle or Monotonic	0	(0) - Static (1) - Triangle (2) - Monotonic		1	UIntegerT	R/W
0x0441	SimStartValue	Value to start with the simulation [L]	0,0	9999,0	-9999,0	4	FloatT	R/W
0x0445	SimIncrement Value	Incrementation value of the simulation [L]	10,0	999,0	-999,0	4	FloatT	R/W
0x0449	SimNumber Intervals	Number of intervals to simulation	20	65000	1	2	UIntegerT	R/W
0x044B	SimTimingIntervals	Timinig [ms] between intervals	50	50000	50	2	UIntegerT	R/W
0x044D	ValueInSiUnit	Saved part volume value in SI unit [L]	0,0	999999,0	-999999,0	4	FloatT	R

Legend

MRE Measuring Range End

MRS Measuring Range Start

19. Manufacturer's declaration



MANUFACTURER'S DECLARATION OF CONFORMITY



We:

Kobold Messring GmbH
Nordring 22-24
65719 Hofheim
Germany

declare under our own responsibility that the product(s):

MIM-1** (IO-Link Device)***

to which this declaration refers conform to:

- IO-Link Interface and System Specification, V1.1, July 2013 (NOTE 1,2)
- IO Device Description, V1.1, August 2011
- IO-Link Interface and System Specification, V1.0, January 2009 (NOTE 1)
- IO Device Description, V1.0.1, March 2010

The conformity tests are documented in the test report:

IO-Link_Device_TestReport_MIM_190301.pdf

Issued at Hofheim, 01.03.2019

Harald Peters
General Manager

Manfred Wenzel
Proxy Holder

Reproduction and all distribution without written authorization prohibited

NOTE 1 Relevant Test specification is V1.1, July 2014

NOTE 2 Additional validity in Corrigendum Package 2015

20. Confirmation for contact with drinking water

Konformitätsbestätigung für den Kontakt mit Trinkwasser
Confirmation for contact with drinking water

TrinkwV (Germany)
WRAS-BS 6920-1:2000 (UK)

Kobold Messring GmbH, Hofheim-Ts., bestätigt hiermit für die Materialien und Gegenstände, die bei bestimmungsgemäßem Gebrauch in Kontakt mit Trinkwasser kommen können, die Konformität der trinkwasserhygienischen Eignung.

Kobold Messring GmbH, Hofheim-Ts., hereby confirms the conformity of the drinking water hygienic suitability for the materials and objects that can come into contact with drinking water when used as intended.

zusammengesetztes Produkt *composite product*

Die Aktualität der Konformitätsbestätigungen der Ausgangsstoffe und der dazugehörige Wareneingang wurden überprüft.
The up-to-dateness of the conformity confirmations of the starting materials and the associated goods receipt were checked.

Gerätetyp	MIM	Magnetisch induktiver Durchflussmesser
model	MIM	Magnetic inductive flow meter

Ausgangsstoffe *raw materials*

Pos. <i>item</i>	Benennung <i>type</i>	Werkstoff <i>material</i>	Materialgruppe <i>material group</i>	Bemerkungen <i>remarks</i>
01	Anschlussfittings <i>connection fittings</i>	1.4404	Metall <i>metal</i>	
02	Elektroden <i>electrodes</i>	1.4404	Metall <i>metal</i>	
03	Temperaturfühler <i>temperature sensor</i>	1.4404	Metall <i>metal</i>	
04	Isolierteil <i>isolating part</i>	PEEK	Kunststoff <i>plastic</i>	
05	Dichtungen <i>seals</i>	EPDM	Elastomer <i>elastomer</i>	
06				
07				
08				
09				
10				

10.02.2022

ppa Manfred Wenzel

Datum date

Unterschrift
signature

Leiter Compliance
compliance manager

Dieses EDV-Dokument ist ohne persönliche Unterschrift gültig! *This electronic document is valid without any signature!*

QS03-09 Änd. 02/22

21. EU Declaration of Conformance

We, KOBOLD Messring GmbH, Hofheim-Ts, Germany, declare under our sole responsibility that the product:

Electromagnetic Flowmeter

Model: MIM -1xxxxxxxxxx

to which this declaration relates is in conformity with the standards noted below:

EN 61326-1:2013

Electrical equipment for measurement, control and laboratory use – EMC requirements - Part 1: General requirements

EN 60529:2014

Degrees of protection provided by enclosures (IP Code)

DIN EN IEC 63000:2018

Technical documentation for the assessment of electrical and electronic products with respect to the restriction of hazardous substances

Also, the following EC guidelines are fulfilled:

2014/30/EU

EMC Directive

2011/65/EU

RoHS (category 9)

2015/863/EU

Delegated Directive (RoHS III)

Additional for MIM-13xxx:

Regulation (EC) No 1935/2004
materials and articles intended to come into contact with food and repealing

materials and articles intended to come into contact with food and repealing

Regulation (EC) No. 2023/2006
articles intended to come into contact with food)

good manufacturing practice for materials and articles intended to come into contact with food)

Hofheim, 21 May 2021

H. Volz
General Manager

M. Wenzel
Proxy Holder

22. UK Declaration of Conformity

We, KOBOLD Messring GmbH, Hofheim-Ts, Germany, declare under our sole responsibility that the product:

Electromagnetic Flowmeter

Model: MIM -1xxxxxxxxxx

to which this declaration relates is in conformity with the standards noted below:

BS EN 61326-1:2013

Electrical equipment for measurement, control and laboratory use. EMC requirements. General requirements

BS EN 60529:1992+A2:2013

Degrees of protection provided by enclosures (IP-Code)

BS EN IEC 63000:2018

Technical documentation for the assessment of electrical and electronic products with respect to the restriction of hazardous substances.

Also, the following UK guidelines are fulfilled:

S.I. 2016/1091

Electromagnetic Compatibility Regulations 2016

S.I. 2012/3032

The Restriction of the Use of Certain Hazardous Substances in Electrical and Electronic Equipment Regulations 2012

Additional for MIM-13xxx:

Regulation (EC) No 1935/2004
contact with food and repealing

materials and articles intended to come into

Regulation (EC) No. 2023/2006

articles intended to come into contact with food)

H. Volz
General Manager

M. Wenzel
Proxy Holder

Hofheim, 24 May 2021