



Supplementary Manual for DUC-MF MODBUS

BUS functionality via RS485 interface



Index

Index.....	2
1. Introduction.....	3
1.1. Precondition for MODBUS usage.....	3
1.2. Supplied MODBUS operation modes.....	3
1.3. Installation Hints.....	4
2. Parameterization of DUC-MF for MODBUS functionality.....	7
3. MODBUS communication structure.....	8
3.1. MODBUS request register structure.....	8
3.2. MODBUS Master → Slave Communication- Example.....	9
4. MODBUS Register Overview.....	10
4.1. Register Overview of Measurement Values 1 Channel device (Big Endian) software version 1.XX.XX.....	10
4.2. Register Overview of measured variable for 2 channel flowmeter (Big Endian) dwc-f software version 1.XX.XX.....	11
4.3. Register Overview of Measurement Values 1 Channel device (Big Endian) dwc-f software version 2.XX.XX.....	12
4.4. Register Overview of measured variable for 2 channel flowmeter (Big Endian) dwc-f software version 2.XX.XX.....	13
4.5. Volume flow units Register overview.....	14
4.6. Fluid Velocity Unit Code Table.....	15
4.7. Flow Totalizer Unit Code Table.....	15
4.8. Power / Heat Code Table.....	16
4.9. Temperature Unit Code Table.....	16
4.10. Status Message Code Table.....	17
5. Disposal.....	18



The instruction manuals on our website www.kobold.com are always for currently manufactured version of our products. Due to technical changes, the instruction manuals available online may not always correspond to the product version you have purchased. If you need an instruction manual that corresponds to the purchased product version, you can request it from us free of charge by email (info.de@kobold.com) in PDF format, specifying the relevant invoice number and serial number. If you wish, the operating instructions can also be sent to you by post in paper form against an applicable postage fee.

1. Introduction

1.1. Precondition for MODBUS usage

DUC-MF ultrasonic flowmeter supports starting from firmware version V1.21 MODBUS functionality together with the optional RS485 interface.

That means, that you are able to use MODBUS functionality. Your DUC-MF flowmeter must be equipped with a RS485 interface and firmware version 1.21 or higher.

1.2. Supplied MODBUS operation modes

DUC-MF supports MODBUS standards RTU and ASCII.

MODBUS RTU:

(RTU=Remote Terminal Unit), the measurement data will be transferred as binary data stream.

MODBUS ASCII:

(ASCII=American Standard Code for Information Interchange), the measurement data will be transferred as text format.

Attention!

The MODBUS communication takes place at present exclusively in „Request format Function 04“. That means that exclusively measurement data could be request from your DUC-MF. Therefore, it is not possible to change parameter data via MODBUS from your Master (e.g. process control system).

Parameters like site parameters or settings for MODBUS communication must be set direct via soft buttons at the DUC device.

1.3. Installation Hints

The RS 485 Interface is equipped with Push-in double spring terminals, **allowing** a fast and easy installation of cables.

Cables can be connected to the terminals without exertion of force or need of any tools (see picture 1.1). A defined cage of the combined spring ensures stability of the connection: **side slipping** of the conductor is impossible.

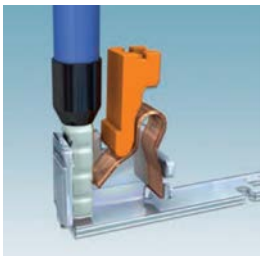

Picture 1.1: Push-In spring connection (Source: www.phoenixcontact.com)

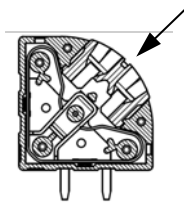

Picture 1.2: Detailed description of a push-in spring connection terminal (source: www.phoenixcontact.com)

The clamp connections are suitable for solid conductors and cable endings with ferrule (1,5 mm² cross section). A cable ending can be easily connected with the cable terminal if it will be feed through the hole of the cable terminal whilst performing a light pressure on the cable ending.

A cable can be loosened by pressing on the nut of the cable terminal with a slot screwdriver (size: 0,4 x 2,5) whilst pulling on the cable ending. If fine-veined cables endings without **ferrules** are connected to the cable terminals or loosened it is recommended to use a screwdriver as described at last.

The integration of DUC-MF in a BUS chain can be performed with a 2 wire connection (plus BUS-GND).

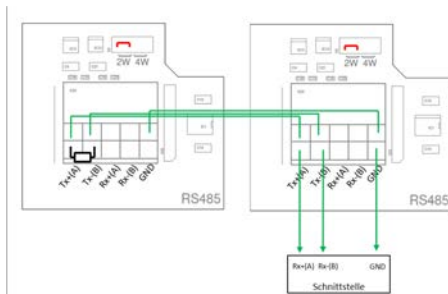

Picture 1.3: Integration of DUC-MF in a BUS chain with negligible noise (simple termination)

Technical details according to the used data BUS

Maximal amount of BUS participants:

- 32 (without repeater)
- Regarding noise level, termination and cable length, the maximal number of allowed devices can be less than 32

Maximal BUS-cable lengths: Differs from the data transfer rate

- 1200 Baud: 1200m
- 115200 Baud: 12m

Grounding:

The RS485 board must be connected directly with protective earth (PE), preferably at one point for the whole BUS (commonly at the DUC-MF master device). In case that the cable shielding is used as common connection (disturbances can be coupled via GND in the RS485 transceiver), the recommendation is that it is connected on two points with PE.

Wire termination (LT)

To minimize reflections at the RS485 cable endings it is necessary to place cable terminations nearby the two endings of the BUS. Important is that both endings will be terminated because the signal propagation is bidirectional.

It is not allowed to place more than two wire terminations (LT) in a passive termination.

Never connect a wire termination (LT) with ground (GND)! The termination must be always connected between both lines (A+ and B+) of the symmetric line.

- Single termination (120 Ohm resistor)
- RC-Termination: between A+ and B-. A capacitor (1nF, 10V minimum) and resistor (120Ohm, 0,25W) in row has to be installed
- Fail-Safe termination active or passive (see polarization)

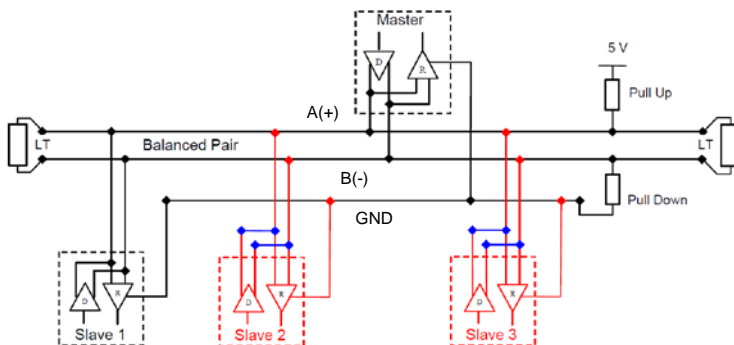

Picture 1.4: Example for a BUS chain with fail safe termination

DUC-MF Modbus

Polarisation (biasing voltage)

If on a RS-485 symmetric pair is no data transfer active, the lines are susceptible against noise or external interferences.

To ensure, that the receiver remains in a constant state, if no data signals will be transferred, a polarisation (biasing voltage) can be used.

- ➔ Pull-Up-Resistor between 5V voltage and A+ line
- ➔ Pull-Down-Resistor between GND and –B line

The value of the resistor shall be between 450 Ohm and 650 Ohm. 650 Ohm resistors allow operation of a higher number of devices in a BUS.

In that case the polarisation shall be implemented on one point for the whole serial bus (in common nearby the master device).

The maximum number of devices in a polarized BUS is reduced about 4 (in comparison to a non-polarized BUS).

2. Parameterization of DUC-MF for MODBUS functionality

Please access from main menu to submenu item “6 Serial / MODBUS”, afterwards chose MODBUS setup.

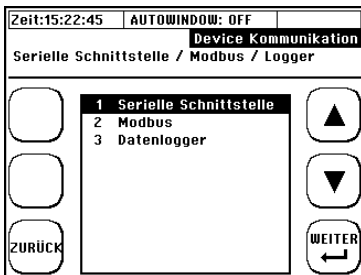

In following setup window it can be chosen all necessary setting for MODBUS setup.

Slave Adress	0...247
Mode	RTU, ASCII
Baudrate	9600, 19200, 38400, 56000, 57600, 115200
Parity	Odd, Even, Non
Data Bits	8
Stop Bits	1
Factory Reset	Yes, No
Modbus Endian	Big Endian, Little Endian

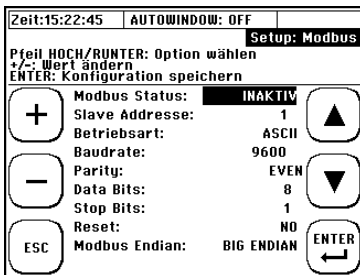

3. MODBUS communication structure

3.1. MODBUS request register structure

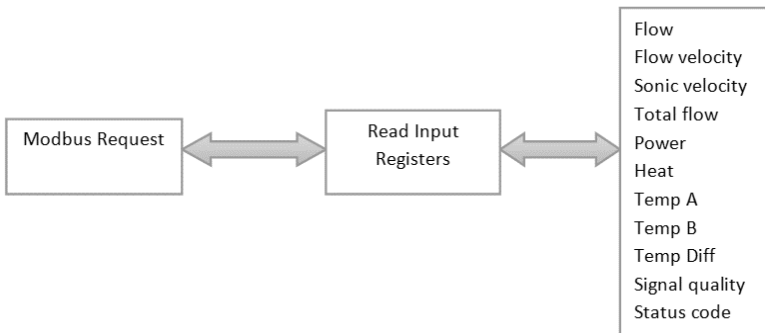

MODBUS registers are only readout registers. MODBUS master PC applications provide the possibility to display in double data types (double words = 2 x 2 Byte = 32bit).

The bytes will be output according the chosen Endian-Coding (byte sequence) It can be chosen between Big- and Little-Endian Coding.

Overview - Depiction of the number 439 041 101 (Hexadecimal depiction: 1A2B3C4D) in different coding modes)

	Big		Little		Middle		Mixed	
	Endian		Endian		Endian		Endian	
Adresse	Hex	Dez	Hex	Dez	Hex	Dez	Hex	Dez
10000	1A	26	4D	77	2B	43	3C	60
10001	2B	43	3C	60	1A	26	4D	77
10002	3C	60	2B	43	4D	77	1A	26
10003	4D	77	1A	26	3C	60	2B	43

3.2. MODBUS Master → Slave Communication- Example

Master request example to read all the status registers at a time: The following example is explained in RTU mode. An ASCII mode instead of single byte hex, it will be 2 ASCII char.

Request	
Field name	Hex
Slave address	01
Function code	04 (read input register)
Starting address Hi	00
Starting address Lo	00
Number of input register. Hi	00
Number of input register. Lo	2E

Slave response assuming that the decimal flow value (fist 4 byte – see register overview) is 87.92 (4-byte double):

Response	
Field name	Hex
Slave address	01
Function code	04 (read input register)
Byte count	36
Input register 0x00. Hi	DA
Input register 0x00. Lo	10
Input register 0x01. Hi	42
Input register 0x01. Lo	AF
.....	
Input register 0x1A. Lo	0x00

4. MODBUS Register Overview

The total Input Register size is 125 double words (250 byte). The MODBUS register address will start from 0 up to 124. At the current sate only the first 17 double words contain valid results.

4.1. Register Overview of Measurement Values 1 Channel device (Big Endian) software version 1.XX.XX

Parameter	Input Register Address (Hex)	Input Registers (Size)	Format (Big Endian)
Flow	0x0000 - 0x0001	2	Float AB CD
Flow Unit Code	0x0002	1	unsigned
Fluid velocity	0x0003 - 0x0004	2	Float AB CD
Sonic velocity	0x0005 – 0x0006	2	Float AB CD
Fluid velocity Unit Code	0x0007	1	unsigned
Total Flow	0x0008 - 0x0009	2	Float AB CD
Total Flow Unit Code	0x000A	1	unsigned
Thermal output	0x000B – 0x000C	2	Float AB CD
Thermal output Unit Code	0x000D	1	unsigned
Heat quantity	0x000E – 0x000F	2	Float AB CD
Heat quantity Unit Code	0x0010	1	unsigned
Temperature A	0x0011 – 0x0012	2	Float AB CD
Temperature B	0x0013 – 0x0014	2	Float AB CD
Temperature differential (T2-T1)	0x0015 – 0x0016	2	Float AB CD
Temperature differential unit Code	0x0017	1	unsigned
Signal Quality	0x0018 – 0x0019	2	Float AB CD
DUC device status text code	0x001A	1	unsigned
Reserve	0x001B to 0x007C	98(0x62)	

4.2. Register Overview of measured variable for 2 channel flowmeter (Big Endian) dwc-f software version

1.XX.XX

Parameter	Input Register Adresse (Hex)	Count of input Register (Decimal)	Format (Big Endian)
Flow CH1	0x0000 – 0x0001	2	Float AB CD
Flow CH2	0x0002 – 0x0003	2	Float AB CD
Flow Unit Code	0x0004	1	unsigned
Fluid velocity CH1	0x0005 – 0x0006	2	Float AB CD
Fluid velocity CH2	0x0007 – 0x0008	2	Float AB CD
Sonic velocity CH1	0x0009	2	Float AB CD
Sonic velocity CH2	0x000A – 0x000B	2	Float AB CD
Fluid velocity Unit Code	0x000C	1	unsigned
Total flow CH1	0x000D – 0x000E	2	Float AB CD
Total flow CH2	0x000F – 0x0010	2	Float AB CD
Total flow Unit Code	0x0011	1	unsigned
Thermal output (CH1+CH2)/2	0x0012 – 0x0013	2	Float AB CD
Thermal output Unit Code	0x0014	1	unsigned
Heat quantity (CH1+CH2)/2	0x0015 - 0x0016	2	Float AB CD
Heat quantity Unit Code	0x0017	1	unsigned
Temperature A	0x0018 - 0x0019	2	Float AB CD
Temperature B	0x001A – 0x001B	2	Float AB CD
Temperature differential	0x001C - 0x001D	2	Float AB CD
Temperature differential Unit Code	0x001E	1	unsigned
Signal quality CH1	0x001F– 0x0020	2	Float AB CD
Status CH1	0x0021	1	unsigned
Signal quality CH2	0x0022 - 0x0023	2	Float AB CD
Status CH2	0x0024	1	unsigned
Reserve	0x0025 - 0x007C	88(0x58)	

4.3. Register Overview of Measurement Values 1 Channel device (Big Endian) dwc-f software version 2.XX.XX

Parameter	Input Register Address (Hex)	Input Registers (Size)	Format (Big Endian)
Flow	0x0000 - 0x0001	2	Float AB CD
Flow Unit Code	0x0002	1	unsigned
Fluid velocity	0x0003 - 0x0004	2	Float AB CD
Sonic velocity	0x0005 – 0x0006	2	Float AB CD
Fluid velocity Unit Code	0x0007	1	unsigned
Total Flow	0x0008 - 0x0009	2	Float AB CD
Total Flow Unit Code	0x000A	1	unsigned
Thermal output	0x000B – 0x000C	2	Float AB CD
Thermal output Unit Code	0x000D	1	unsigned
Heat quantity	0x000E – 0x000F	2	Float AB CD
Heat quantity Unit Code	0x0010	1	unsigned
Analog Input A	0x0011 – 0x0012	2	Float AB CD
Analog Input B	0x0013 – 0x0014	2	Float AB CD
Temperature A	0x0015 – 0x0016	2	Float AB CD
Temperature B	0x0017 – 0x0018	2	Float AB CD
Temperature differential (T2-T1)	0x0019 – 0x001A	2	Float AB CD
Temperature differential unit Code	0x001B	1	unsigned
Signal Quality	0x001C – 0x001D	2	Float AB CD
DUC device status text code	0x001E	1	unsigned
Reserve	0x001F – 0x0020		Float AB CD

4.4. Register Overview of measured variable for 2 channel flowmeter (Big Endian) dwc-f software version 2.XX.XX

Parameter	Input Register Adresse (Hex)	Count of input Register (Decimal)	Format (Big Endian)
Flow CH1	0x0000 – 0x0001	2	Float AB CD
Flow CH2	0x0002 – 0x0003	2	Float AB CD
Flow Unit Code	0x0004	1	unsigned
Fluid velocity CH1	0x0005 – 0x0006	2	Float AB CD
Fluid velocity CH2	0x0007 – 0x0008	2	Float AB CD
Sonic velocity CH1	0x0009	2	Float AB CD
Sonic velocity CH2	0x000A – 0x000B	2	Float AB CD
Fluid velocity Unit Code	0x000C	1	unsigned
Total flow CH1	0x000D – 0x000E	2	Float AB CD
Total flow CH2	0x000F – 0x0010	2	Float AB CD
Total flow Unit Code	0x0011	1	unsigned
Thermal output (CH1+CH2)/2	0x0012 – 0x0013	2	Float AB CD
Thermal output Unit Code	0x0014	1	unsigned
Heat quantity (CH1+CH2)/2	0x0015 - 0x0016	2	Float AB CD
Heat quantity Unit Code	0x0017	1	unsigned
Analoge Input A	0x0018 - 0x0019	2	Float AB CD
Analoge Input B	0x001A – 0x001B	2	Float AB CD
Temperature A	0x001C - 0x001D	2	Float AB CD
Temperature B	0x001E - 0x001F	2	Float AB CD
Temperature differential	0x0020 – 0x0021	2	Float AB CD
Temperature differential Unit Code	0x0022	1	unsigned
Signal quality CH1	0x0023 – 0x0024	2	Float AB CD
Status CH1	0x0025	1	unsigned
Signal quality CH2	0x0026 – 0x0027	2	Float AB CD
Status CH2	0x0028	1	unsigned
Reserve	0x0029 – 0x007C	88(0x58)	

4.5. Volume flow units Register overview

(Input Register: 0x0002)

Flow unit code	Flow unit
0x00	m ³ /s
0x01	m ³ /min
0x02	m ³ /h
0x03	l/s
0x04	l/min
0x05	l/h
0x06	gal/s
0x07	gal/min
0x08	gal/h
0x09	ft ³ /s
0x0A	ft ³ /min
0x0B	ft ³ /h
0x0C – 0xFF	Reserve

4.6. Fluid Velocity Unit Code Table

(Input Register: 0x0007)

Fluid velocity code	Fluid velocity unit
0x00	m/s
0x01	ft/s
0x02 – 0xFF	Reserved

4.7. Flow Totalizer Unit Code Table

(Input Register: 0x0007)

Total flow unit code	Total Flow unit
0x00	m ³
0x01	l
0x02	gal
0x03	ft ³
0x04 – 0xFF	Reserved

4.8. Power / Heat Code Table

(Input Register: 0x0010)

Heat quantity unit code	Heat quantity unit
0x00	MWh
0x01	kWh
0x02	Wh
0x03	BTU[I.T]
0x04	J
0x05 – 0xFF	Reserved

4.9. Temperature Unit Code Table

(Input Register: 0x0017)

Temp unit code	Temp unit
0x00	C (Celsius)
0x01	F (Fahrenheit)
0x02 – 0xFF	Reserved

4.10. Status Message Code Table

(Input Register: 0x001A)

Status text code	Device status
0x00	OK
0x01	NO SIG
0x02	WSCAN
0x03 – 0xFF	Reserve

5. Disposal

Note!

- Avoid environmental damage caused by media-contaminated parts
- Dispose of the device and packaging in an environmentally friendly manner
- Comply with applicable national and international disposal regulations and environmental regulations.

Batteries

Batteries containing pollutants are marked with a sign consisting of a crossed-out garbage can and the chemical symbol (Cd, Hg, Li or Pb) of the heavy metal that is decisive for the classification as containing pollutants:

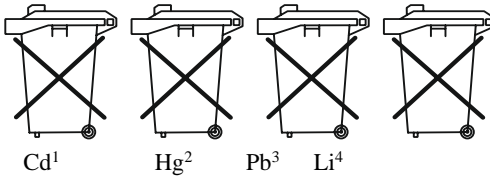

1. „Cd" stands for cadmium
2. „Hg" stands for mercury
3. „Pb" stands for lead
4. „Li" stands for lithium

Electrical and electronic equipment



Notes: _____

Kobold Messring GmbH
Nordring 22-24
D-65719 Hofheim
Tel.: +49(0)6192-2990
Fax: +49(0)6192-23398
E-Mail: info.de@kobold.com
Internet: www.kobold.com