

# S100



## THE UNIVERSAL MINIATURE PHOTOELECTRIC SENSOR

- Two threaded front mounting holes
- Two slotted rear mounting holes
- Anti-tampering sensor (no adjustment)
- Standard optic functions
- Transparent object detection
- M8 connector and cable models
- PNP or NPN models with Light/Dark selection by wire
- Plastic housing, IP67 mechanical protection

### APPLICATIONS

- Processing and packaging machines
- Conveyors
- Automatic warehousing
- Intralogistic lines
- Bottling
- Cosmetic and Pharma machinery



S100		
<b>Through beam</b>		12 m
<b>Retroreflective</b>		7 m
<b>Polarized Retroreflective (long range)</b>		5,5 m
<b>Polarized Retroreflective (short range)</b>		3 m
<b>Transparent Retroreflective (short range)</b>		500 mm
<b>Transparent Retroreflective (long range)</b>		2 m
<b>Diffused proximity (short range)</b>		300 mm
<b>Diffused proximity (long range)</b>		500 mm
<b>Fixed focus</b>		70 mm
<b>Background Suppression (short range)</b>		100 mm
<b>Background Suppression (long range)</b>		200 mm
<b>Power supply</b>	Vdc	10...30 Vdc
<b>Output</b>	PNP	•
	NPN	•
<b>Connection</b>	cable	2 m cable, 4 wires
	connector	M8 conn., 4-pole
<b>Approximate dimensions (mm)</b>		32x20x12
<b>Housing material</b>		Plastic
<b>Mechanical protection</b>		IP67

# TECHNICAL DATA

<b>Power supply</b>	10 ... 30 Vdc
<b>Ripple</b>	10% max.
<b>Consumption (output current excluded)</b>	20 mA max.
<b>Light emission</b>	red LED 632 nm (mod. S100...B/C/D/M01) IR LED 860 nm (mod. S100...A/G/Txx/M10)
<b>Setting</b>	remote teach-in (mod. S100...Mxx/Txx)
<b>Operating mode</b>	LIGHT/DARK selectable by wire (mod. S100...A/B/C/D/F)
<b>Indicators</b>	yellow OUTPUT LED (excl. mod. G) green POWER LED (mod. S100...G)
<b>Output</b>	PNP or NPN
<b>Output current</b>	100 mA
<b>Saturation voltage</b>	2 V max.
<b>Response time</b>	2 ms (mod. S100...FG) 1 ms (mod. S100...A/Bxx/C/D/Mxx/Txx) 250 Hz (mod. S100...FG)
<b>Switching frequency</b>	500 Hz (mod. S100...A/Bxx/C/D/Mxx/Txx)
<b>Connection</b>	2 m cable 3,5 mm, M8 4-pole connector
<b>Dielectric strength</b>	500 Vac, 1 min between electronics and housing
<b>Insulating resistance</b>	>20 MΩ, 500 Vdc between electronics and housing
<b>Mechanical protection</b>	IP67
<b>Ambient light rejection</b>	according to EN 60947-5-2
<b>Vibrations</b>	0,5 mm amplitude, 10 ... 55 Hz frequency, for every axis (EN60068-2-6)
<b>Shock resistance</b>	11 ms (30 G) 6 shock for every axis (EN60068-2-27)
<b>Housing material</b>	ABS body, PMMA indicators cover
<b>Lens material</b>	PC lens, PMMA window
<b>Operating temperature</b>	-25... 55 °C
<b>Storage temperature</b>	-40 ... 70 °C
<b>Weight</b>	50 g max. cable vers., 10 g max. connector vers.

# DIMENSIONS

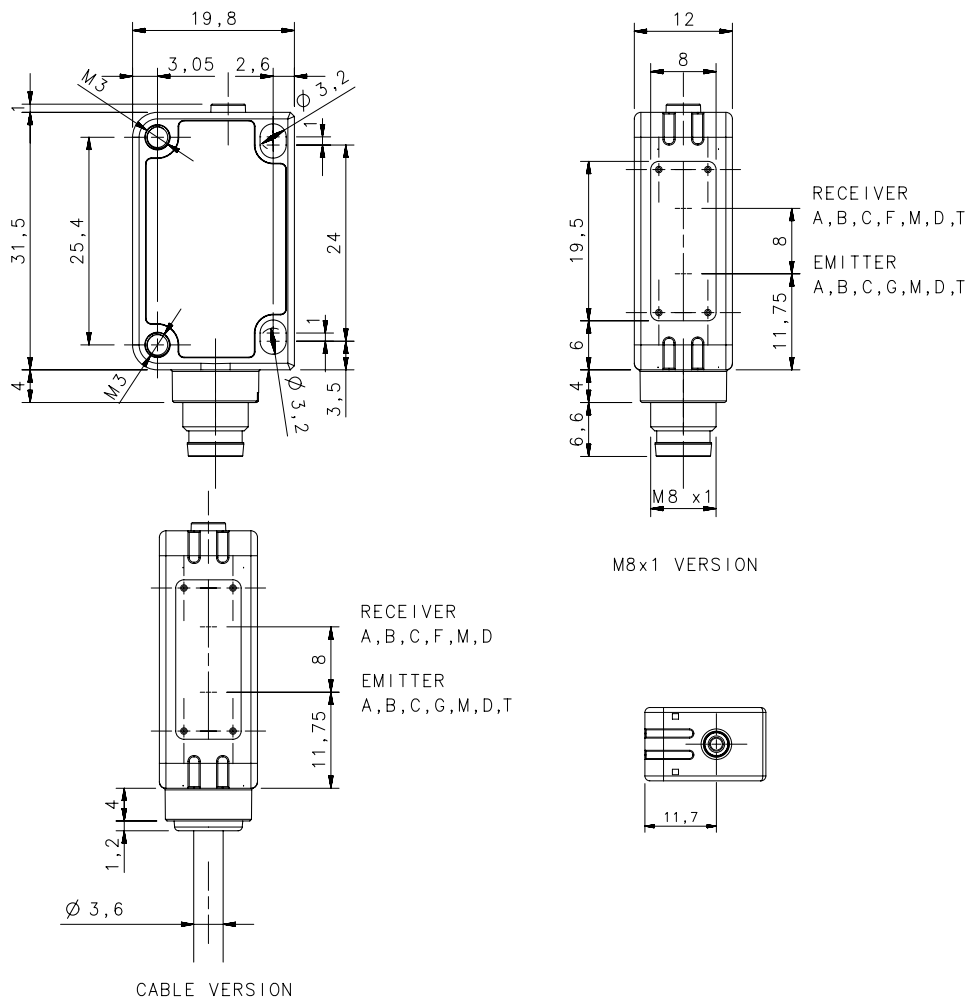

# CONNECTIONS

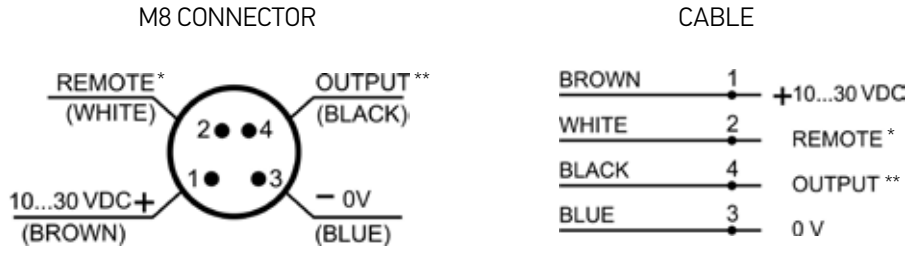

\*REMOTE: Light/Dark selection (S100-...-A-B-C-D-F), External Teach-in (S100-...-Mxx/Txx)  
 \*\*OUTPUT: PNP or NPN depends on the model

# INDICATORS AND SETTINGS

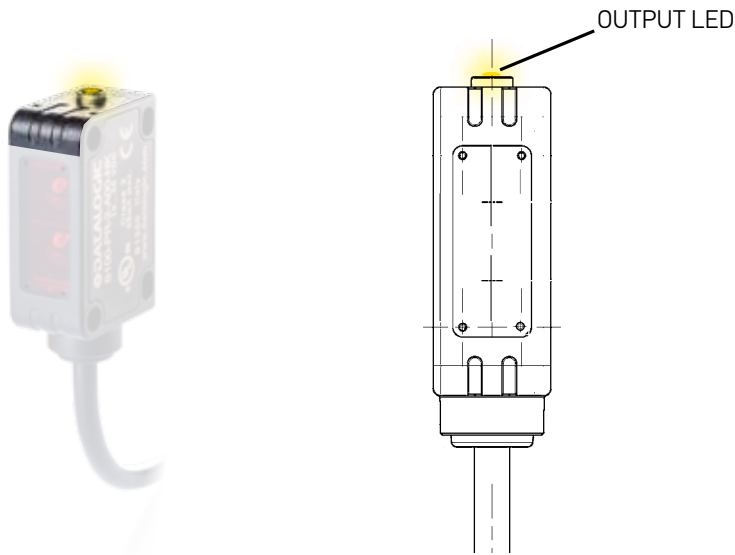

# DETECTION DIAGRAMS

## THROUGH BEAM

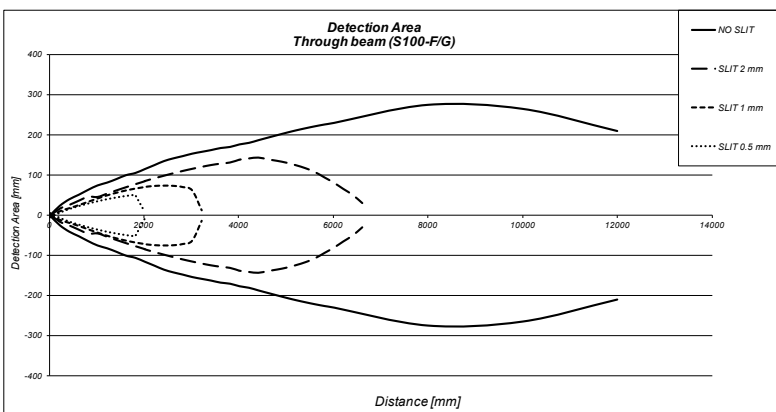

	max. operating distance
NO SLIT	12 m
2 mm SLIT	6,7 m
1 mm SLIT	3,2 m
0,5 mm SLIT	2 m

## DIFFUSE PROXIMITY

	SHORT RANGE (S100-...-C0)	LONG RANGE (S100-...-C1)
Recommended operating distance (on White 90% target)	10...240 mm	2...400 mm
Maximum operating distance (White 90% target)	1...300 mm	0...500 mm
Maximum operating distance (Grey 18% target)	20...150 mm	10...280 mm
Maximum operating distance (Black 6% target)	30...80 mm	20...160 mm
Difference White-Grey	50%	50%
Difference White-Black	75%	75%
Hysteresis	20%	20%

### DIFFUSE (SHORT RANGE: S100-C00)

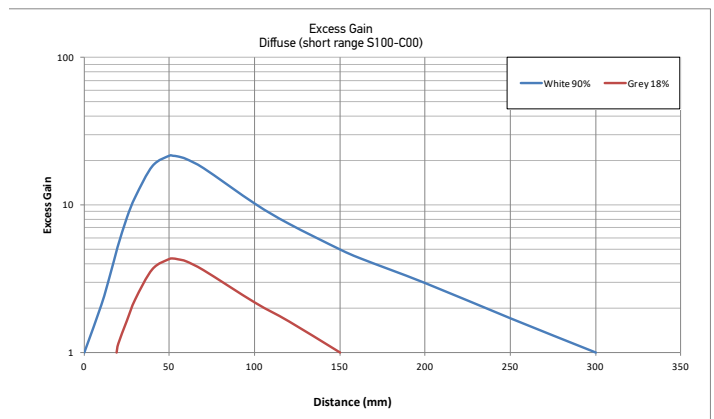
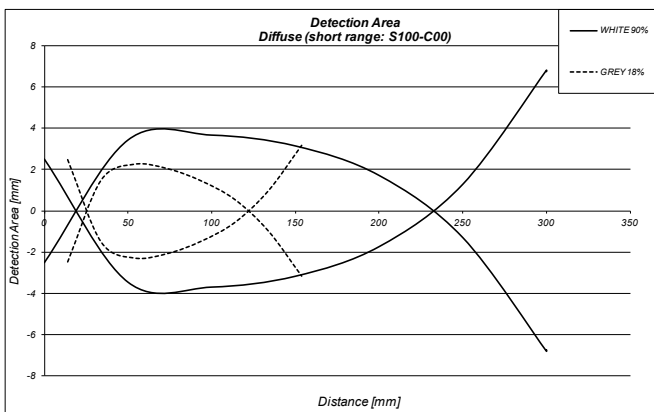

### DIFFUSE (LONG RANGE: S100-C10)

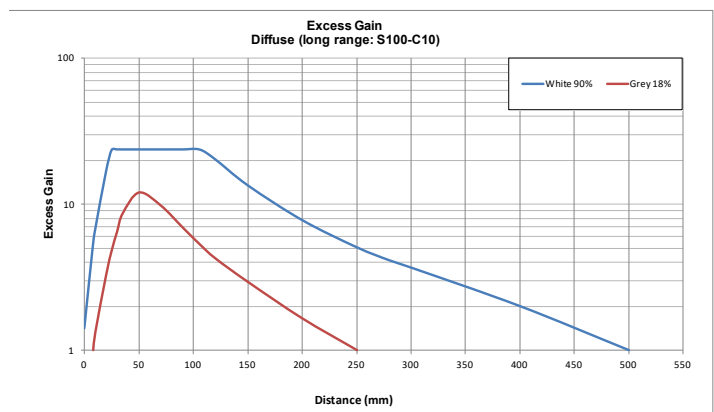
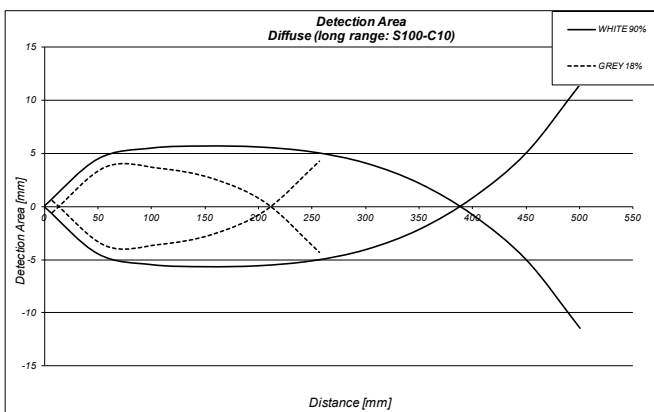

## POLARIZED RETROREFLECTIVE

REFLECTOR	TYPE	SHORT RANGE (S100-...-B00)	LONG RANGE (S100-...-B10)
R1	circular (23 mm)	0,2..0,8 m	0,02..2 m
R2	circular (48 mm)	0,03..2 m	0,01..4,5 m
R3	rectangular (18x54 mm)	0,03..1,5 m	0,01..3 m
R4	rectangular (47x47 mm)	0,03..2,5 m	0,01..4,5 m
R5	circular (75 mm)	0,01..3 m	0,01..5,5 m
R6	rectangular (36x55 mm)	0,03..1,8 m	0,01..4 m
RT3970	self-adhesive tape (60x40 mm)	0,2..0,8 m	0,05..1,8 m



	max. operating distance			
	SHORT RANGE (S100-...-B00)		LONG RANGE (S100-...-B10)	
	with R5 reflector	with R2 reflector	with R5 reflector	with R2 reflector
<b>NO SLIT</b>	0,02 ... 3 m	0,02 ... 2 m	0,1...5,5 m	0,01...4,5 m
<b>2 mm SLIT</b>	0,05 ... 1,5 m	0,05 ... 0,8 m	0,2...4 m	0,03...3 m
<b>1 mm SLIT</b>	-	-	0,3...2,5 m	0,05...1,5 m
<b>0,5 mm SLIT</b>	-	-	0,5...1,2 m	0,07...0,7 m

### POLARIZED RETROREFLECTIVE (SHORT RANGE: S100-B00)

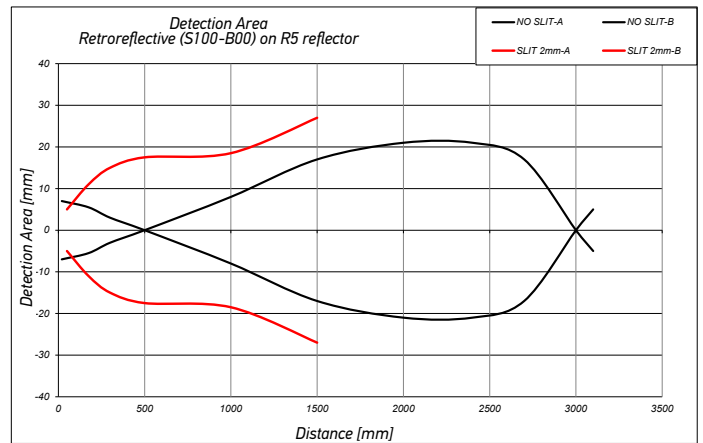
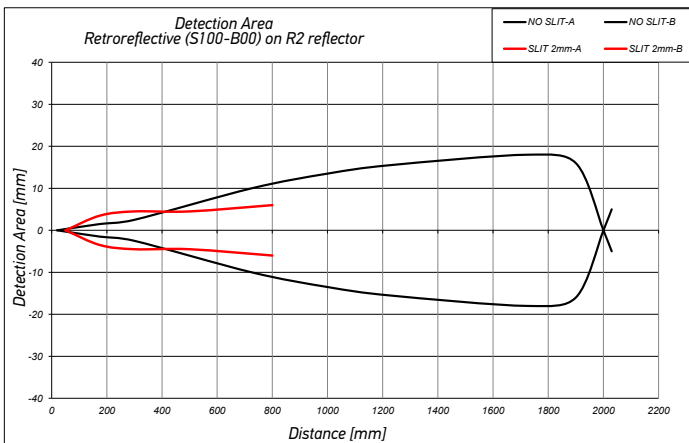

### POLARIZED RETROREFLECTIVE (LONG RANGE: S100-B10)

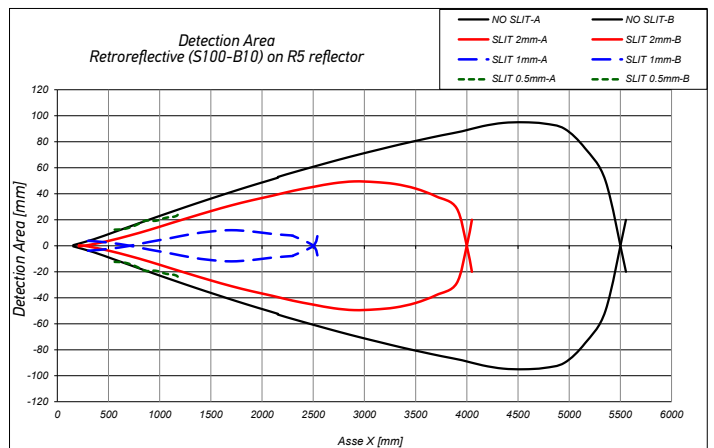
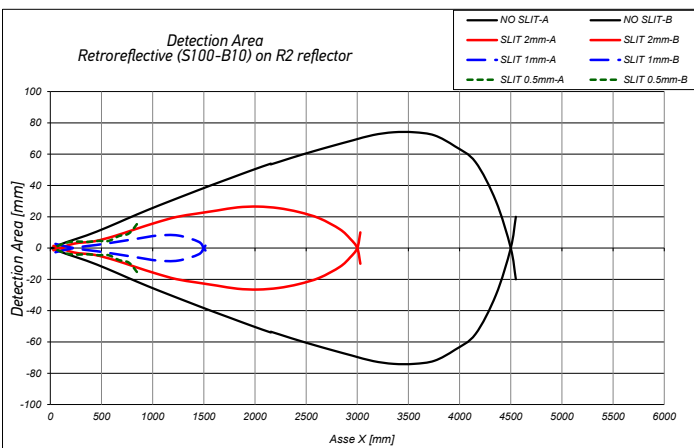

## RETROREFLECTIVE (INFRARED)

REFLECTOR	TYPE	(S100-...-A00)
R1	circular (23 mm)	0.03.3 m
R2	circular (48 mm)	0.01.6 m
R3	rectangular (18x54 mm)	0.01.3.5 m
R4	rectangular (47x47 mm)	0.01.5 m
R5	circular (75 mm)	0.01.7 m
R6	rectangular (36x55 mm)	0.01.6 m
RT3970	self-adhesive tape (60x40 mm)	0.05.2 m



	max. operating distance	
	with R5 reflector	with R2 reflector
NO SLIT	7 m	6 m
2 mm SLIT	4,7 m	3,4 m
1 mm SLIT	2,7 m	2,3 m
0,5 mm SLIT	1,5 m	1 m

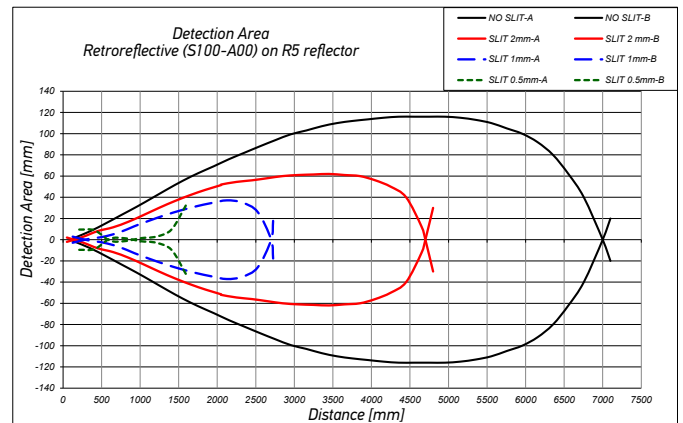
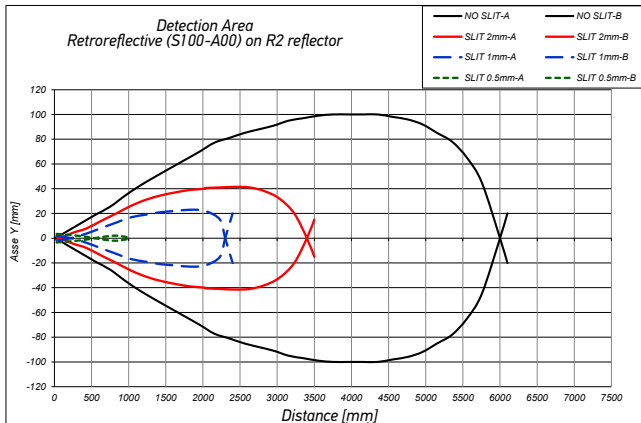

## FIXED FOCUS

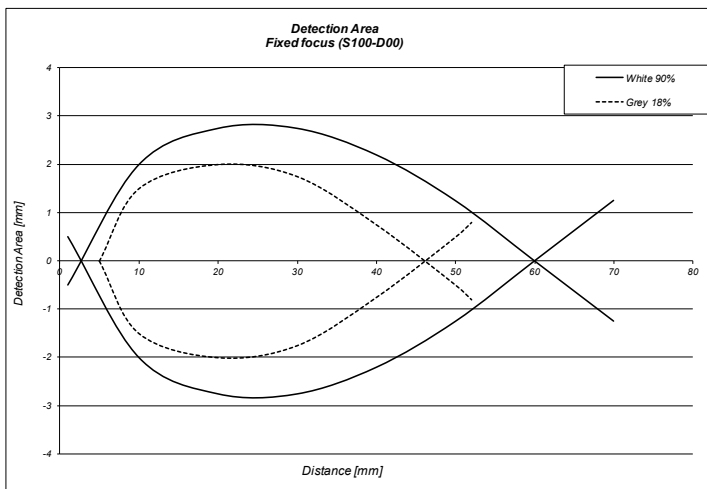

Focus point	70 mm
Maximum operating distance (White 90%)	70 mm
Maximum operating distance (Grey 18%)	55 mm
Difference White/Black	25%

## RETROREFLECTIVE FOR TRANSPARENT (INFRARED)

REFLECTOR	TYPE	SHORT RANGE (S100-...-T00)	LONG RANGE (S100-...-T10)
R1	circular (23 mm)	0.1...0.3 m	0.4...1 m
R2	circular (48 mm)	0.1...0.5 m	0.8...2 m
R3	rectangular (18x54 mm)	0.1...0.3 m	0.4...1 m
R4	rectangular (47x47 mm)	0.1...0.5 m	0.8...2 m
R5	circular (75 mm)	0.1...0.8 m	0.8...2.5 m
R6	rectangular (36x55 mm)	0.1...0.5 m	0.8...2m
RT3970	self-adhesive tape (60x40 mm)	0.15...0.3 m	0.1...0.8 m



	max. operating distance			
	SHORT RANGE (S100-...-T00)		LONG RANGE (S100-...-T10)	
	with R5 reflector	with R2 reflector	with R5 reflector	with R2 reflector
<b>NO SLIT</b>	0.1...0.8 m	0.1...0.5 m	0.8...2.5 m	0.8...2 m
<b>2 mm SLIT</b>	0.1...0.5 m	0.1...0.3 m	0.5...1.8 m	0.5...1.6 m
<b>1 mm SLIT</b>	-	-	-	-
<b>0,5 mm SLIT</b>	-	-	-	-

## TRANSPARENT RETROREFLECTIVE (SHORT RANGE: S100-T00)

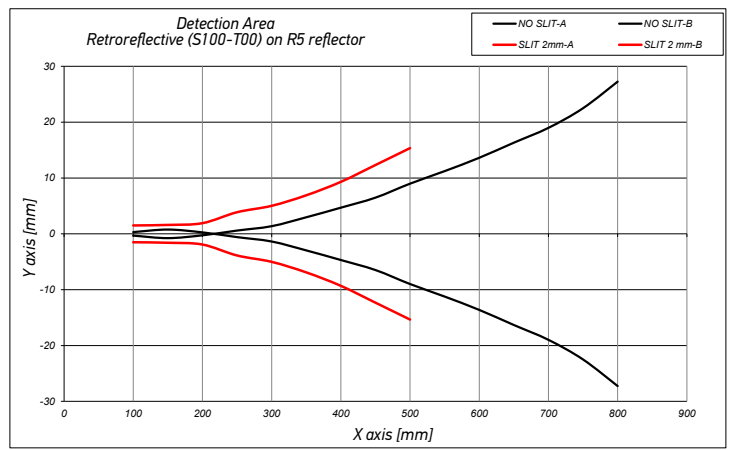
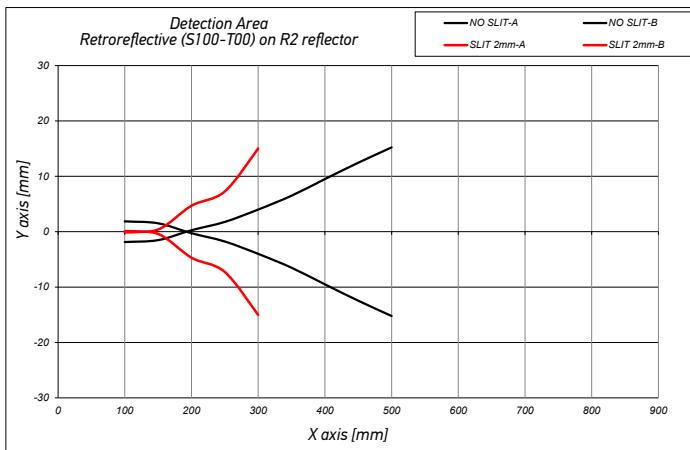

## TRANSPARENT RETROREFLECTIVE (LONG RANGE: S100-T10)

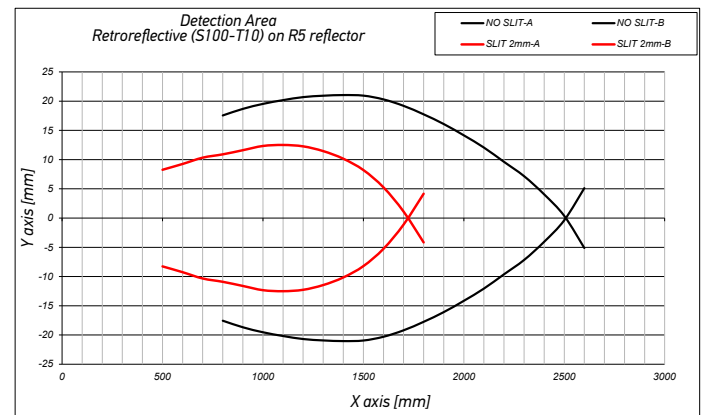
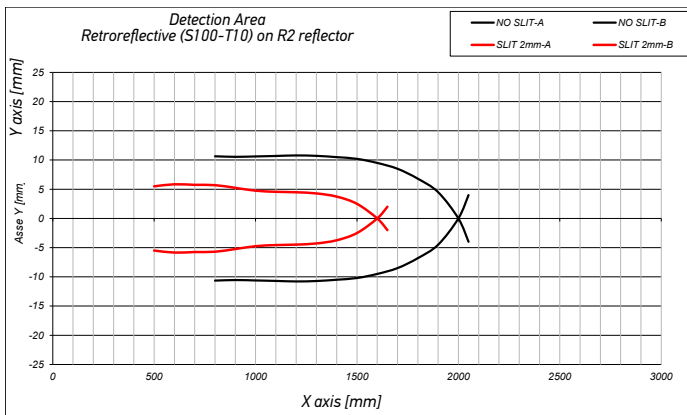

## BACKGROUND SUPPRESSION

Operating distances (background suppression)	30...100 mm	30...200 mm
	S100...M00	S100...M10
Maximum operating distance (White 90%)	0...150 mm	10...250 mm
Maximum operating distance (Grey 18%)	10...110 mm	10...135 mm
Maximum operating distance (Black 6%)	10...80 mm	10...110 mm
Difference White 90%/White 90%	< 5%	< 10%
Difference White 90%/Grey 18%	< 15%	< 32%
Difference White 90%/Black 6%	< 25%	< 45%

### BACKGROUND SUPPRESSION (SHORT RANGE: S100-M00)

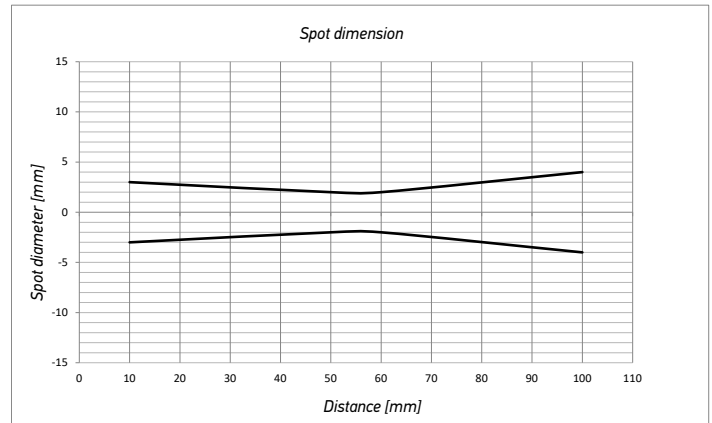
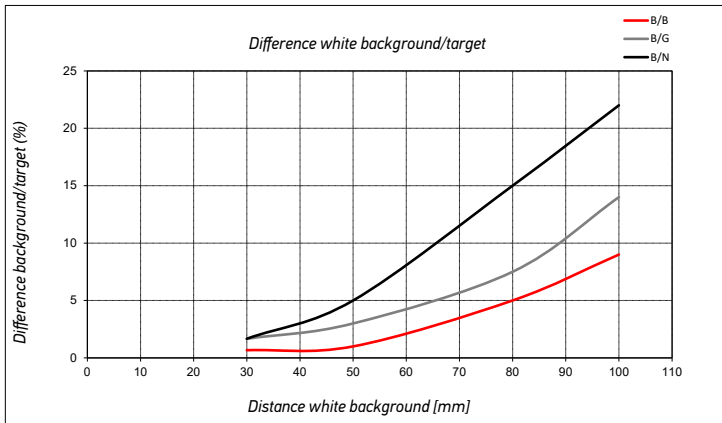

### BACKGROUND SUPPRESSION (LONG RANGE: S100-M10)

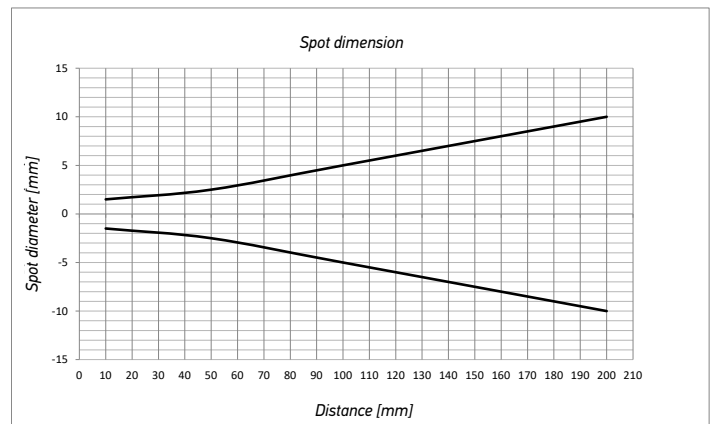
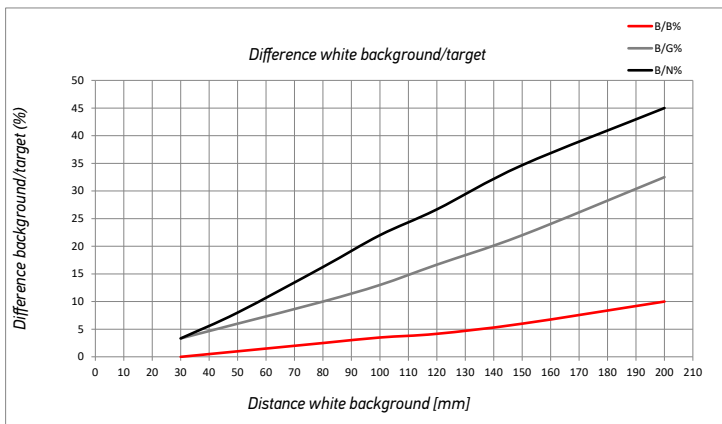



# MODEL SELECTION AND ORDER INFORMATION

OPTIC FUNCTION	EMISSION	OPERATING DISTANCE	CONNECTION	OUTPUT	MODEL	ORDER No.
Through beam	IR	12 m	2 m cable	NPN	S100-PR-2-FG00-NK	950811100
				PNP	S100-PR-2-FG00-PK	950811110
			M8 connector	NPN	S100-PR-5-FG00-NK	950811240
				PNP	S100-PR-5-FG00-PK	950811250
Retroreflective	IR	7 m	2 m cable	NPN	S100-PR-2-A00-NK	950811000
				PNP	S100-PR-2-A00-PK	950811010
			M8 connector	NPN	S100-PR-5-A00-NK	950811140
				PNP	S100-PR-5-A00-PK	950811150
Polarized Retroreflective (short)	RED	2 m	2 m cable	NPN	S100-PR-2-B00-NK	950811020
				PNP	S100-PR-2-B00-PK	950811030
			M8 connector	NPN	S100-PR-5-B00-NK	950811160
				PNP	S100-PR-5-B00-PK	950811170
Polarized Retroreflective (long)	RED	5 m	2 m cable	NPN	S100-PR-2-B10-NK	950811280
				PNP	S100-PR-2-B10-PK	950811290
			M8 connector	NPN	S100-PR-5-B10-NK	950811300
				PNP	S100-PR-5-B10-PK	950811310
Transparent Retroreflective (short)	IR	500 mm	2 m cable	NPN	S100-PR-2-T00-NH	950811330
			2 m cable	PNP	S100-PR-2-T00-PH	950811320
			M8 connector	NPN	S100-PR-5-T00-NH	950811350
			M8 connector	PNP	S100-PR-5-T00-PH	950811340
Transparent Retroreflective (long)	IR	2 m	2 m cable	NPN	S100-PR-2-T10-NH	950811370
			2 m cable	PNP	S100-PR-2-T10-PH	950811360
			M8 connector	NPN	S100-PR-5-T10-NH	950811390
			M8 connector	PNP	S100-PR-5-T10-PH	950811380
Diffuse proximity (short)	RED	300 mm	2 m cable	NPN	S100-PR-2-C00-NK	950811040
				PNP	S100-PR-2-C00-PK	950811050
			M8 connector	NPN	S100-PR-5-C00-NK	950811180
				PNP	S100-PR-5-C00-PK	950811190
Diffuse proximity (long)	RED	500 mm	2 m cable	NPN	S100-PR-2-C10-NK	950811060
				PNP	S100-PR-2-C10-PK	950811070
			M8 connector	NPN	S100-PR-5-C10-NK	950811200
				PNP	S100-PR-5-C10-PK	950811210
Fixed focus	RED	70 mm	2 m cable	NPN	S100-PR-2-D00-NK	950811080
				PNP	S100-PR-2-D00-PK	950811090
			M8 connector	NPN	S100-PR-5-D00-NK	950811220
				PNP	S100-PR-5-D00-PK	950811230
Background suppression (short range)	RED	30...100 mm	2 m cable	NPN	S100-PR-2-M00-NH	950811120
				PNP	S100-PR-2-M00-PH	950811130
			M8 connector	NPN	S100-PR-5-M00-NH	950811260
				PNP	S100-PR-5-M00-PH	950811270
Background suppression (long range)	IR	30...200 mm	2 m cable	NPN	S100-PR-2-M10-NH	950811420
				PNP	S100-PR-2-M10-PH	950811430
			M8 connector	NPN	S100-PR-5-M10-NH	950811400
				PNP	S100-PR-5-M10-PH	950811410

# ACCESSORIES

**ST-5039**

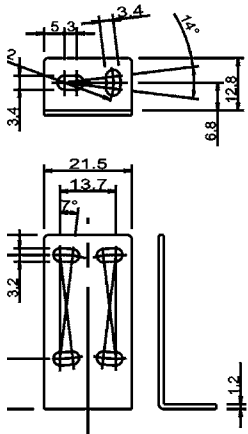

M18 ADAPTER NOSE



**ST-505**

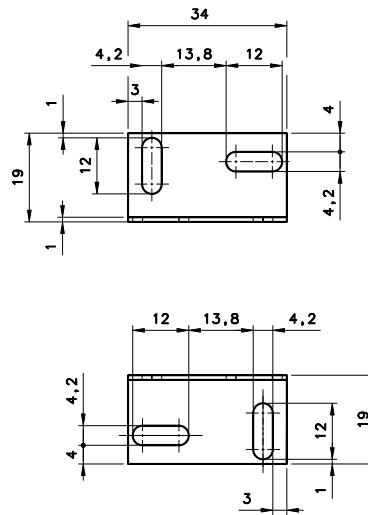

SLIT

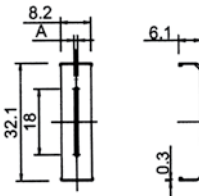

TYPE	MODEL	DESCRIPTION	Order No.
Mounting bracket	ST-505	lateral mounting	95ACC2800
	ST-5039	L-shaped bracket	95ACC2270
Slit	S100-SLIT-05	0,5x19 mm SLIT	95ACC3450
	S100-SLIT-1	1x19 mm SLIT	95ACC3460
	S100-SLIT-2	2x19 mm SLIT	95ACC3470
M18 adapter	ST-S3Z-M18	M18 THREADED ADAPTER NOSE	95ACC7850

# CABLES

TYPE	DESCRIPTION	LENGTH	MODEL	ORDER No.
Axial M8 Connector	4-pole, grey, P.V.C.	3 m	CS-B1-02-G-03	95A251420
		5 m	CS-B1-02-G-05	95A251430
		7 m	CS-B1-02-G-07	95A251440
		10 m	CS-B1-02-G-10	95A251480
	4-pole, P.U.R.	2 m	CS-B1-02-R-02	95A251620
Radial M8 Connector	4-pole, grey, P.V.C.	5 m	CS-B1-02-R-05	95A251640
		3 m	CS-B2-02-G-03	95A251450
		5 m	CS-B2-02-G-05	95A251460
		7 m	CS-B2-02-G-07	95A251470
	4-pole, P.U.R.	10 m	CS-B2-02-G-10	95A251530
		2 m	CS-B2-02-R-02	95A251630
		5 m	CS-B2-02-R-05	95A251650

## DATALOGIC PRODUCT OFFERING

